

**IAME**

THE HEART OF KART

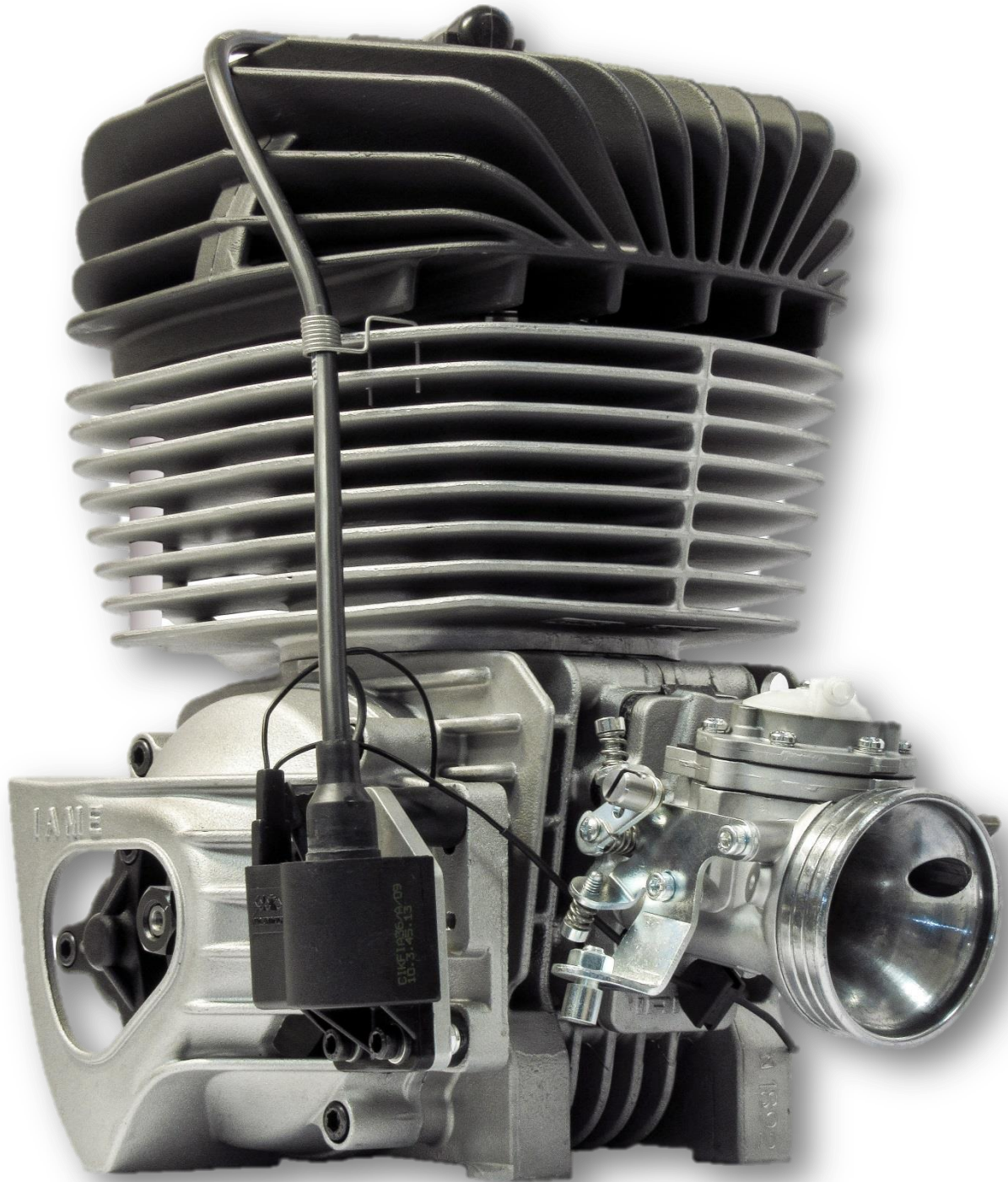

***INSTALLATION MANUAL***  
***REEDJET 100cc -TAG***



# INDEX

	PAGE
General description of engine	01
Engine features / Operational limits	02
Contents of packaging	02
Accessories	03
Engine identification number	04
Section 2	<u>PREPARATION AND INSTALLATION OF THE ENGINE ON THE CHASSIS</u>
2.1.	Installation sketch of the engine on the chassis 05
2.2.	Exhaust manifold installation 06
2.3.	Installation of the carburettor 07
2.4.	Preparation and installation of the engine-mount 08
2.5.	Install the engine on the chassis 09
2.6.	Install the clutch cover with H.T. coil 10
2.7.	Electrical connections 11
2.8.	Install of the inlet silencer 14
2.9.	Install of the exhaust system 14
Section 3	<u>ENGINE USE</u>
3.1.	Mixture, oil and Fuel 15
3.2.	Carburettor setting 16
3.3.	Starting and stopping the engine 17
3.4.	Engine running-in 17
3.5.	Inlet silencer 17
3.6.	Exhaust system warning 17
3.7.	Exhaust gas temperature probe 18
3.8.	Centrifugal Clutch 18
3.9.	Instructions for the clutch disassembly\ assembly 19
3.10.	Battery 20
3.11.	Spark plug and thermal degree 21
3.12.	Choice of the sprocket ratio 22
3.13.	Replacement of the starter brushes 24
3.14.	Scheduled maintenance 30
3.15.	Troubleshooting 31
3.16.	Main Prescriptions 32
3.17.	Wear Status Evaluation Table – Bearing and Halfcrankshaft 33
3.18.	Little / Big end conrod bearing clearance 34
3.19.	Engine and accessories preservation 35
3.20.	Torque Value 35
3.21.	Wiring diagram 36

## GENERAL DESCRIPTION OF ENGINE

This engine of the "TaG" series (Touch and Go) has been expressly designed and developed to power karts for hobby racing on closed tracks, destined for this specific purpose. When designing this new line of engines, the technical solutions already adopted for the high performance engines were applied, in order to guarantee the highest reliability of components, when the operating limits are respected.

The motor is a single cylinder using the two stroke principle.

The cylinder and the crankcase are in aluminium alloy.

The pressed in liner is made of centrifugated cast iron, fully machined to guarantee the best possible stability and sliding homogeneity.

The head is separated from the cylinder and secured by studs.

The crankshaft is built and supported by ball-bearings. The crankshaft is of steel alloy, hardened and tempered, as is the connecting rod which runs on roller bearings.

The ignition includes a 2 pole stator/rotor, an H.T. coil, a starter relay and complete wiring harness.

The spark is generated also without a battery: therefore, in case of emergency, the engine can be started with an external starter unit.

The engine has an integrated electric starter. By pushing the start button, the starter activates a Bendix type gear that engages the starter ring assembled on the clutch.

The engine is provided with a dry centrifugal clutch with low maintenance and with interchangeable sprocket.

The carburettor is a diaphragm type (series Tillotson HW), it includes an integrated fuel pump and filter, and it is able to operate in any position.

The battery (12V - 9Ah) is a sealed, no maintenance battery and is supplied together with a support box, which can be easily adapted to all existing chassis.

The exhaust system, included in the engine package, is already tuned and optimized to ensure the best possible performance.

## ENGINE FEATURES – OPERATIONAL LIMITS

### Engine features:

<ul style="list-style-type: none"> <li>• Cycle:</li> <li>• Original cubic capacity:</li> <li>• Original bore:</li> <li>• Max. theoretical bore:</li> <li>• Stroke:</li> <li>• Lubrication :</li> <li>• Induction:</li> <li>• Carburettor:</li> <li>• Cooling:</li> <li>• Ignition:</li> <li>• Electric Starter:</li> <li>• Clutch:</li> </ul>	<p>OTTO / 2 stroke            100 cm<sup>3</sup>            48.20 mm            48.53 mm            54.05 mm max            Mixture 5%            Reed Valve in crankcase            Diaphragm type , Tillotson HW-33A - Ø24mm            Free Air            Analogical / 2 poles, slotted with internal rotor            12V/0.30 kW            Automatic, dry centrifugal</p>
---	--



### **ATTENTION:**

Never exceed the above limits, no obligation of IAME S.p.A. exists in case the above limits are exceeded.

### Operational RPM limits (the motor not included RPM Limiter):

**Max.RPM / 1' :                    15.000 RPM**

## CONTENT OF PACKAGING

EXHAUST GRUOP	Quantity
• Exhaust muffler spring	2
• Exhaust manifold (no restricted / restricted Ø19mm)	1
• Exhaust muffler	1
INDUCTION GROUP	
• Tillotson Carburettor HW-33A (Venturi Ø24mm)	1
• Inlet Silencer	1
• Inlet Silencer Rubber Manifold	1
• Inlet Silencer Support + Clamps	1
• Carburettor throttle lever cable	1
• Inlet manifold carburettor pipe	1
ELECTRICAL GROUP	
• Battery 12V – 9 Ah	1
• Wiring Harness (with push buttons)	1
• Push Buttons Support Bracket	1
• Battery Support	1
• Battery fix straps	1
• Battery Fixing Clamps	2
• H.T. Coil	1
• Fixing Clamps	8
• Sparkplug NGK BR 10 EG	1
• Sparkplug Cap	1
MISCELLANEUOS	
• Clutch Cover + Accessories	1
• Dual-Lock fixing tape	1

## ACCESSORIES

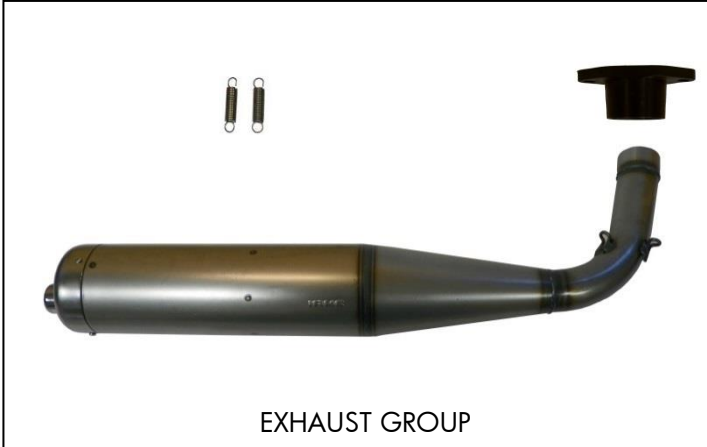

## ENGINE IDENTIFICATION NUMBER

The engine serial number is marked on the front right part of the clutch side crankcase (see fig.) The number normally includes 1 letter, followed by 2 digits numbers, "AU" and 2 other digits numbers (there can be exceptions in some special cases). Other numbers stamped on the crankcase or other surfaces of the motor refer to various manufacturing processes and do not identify the motor.

### ***NOTE:***

*In case of need for spares and when contacting the IAME Support Centers, please always refer to the Engine Serial Number and to the engine model.*

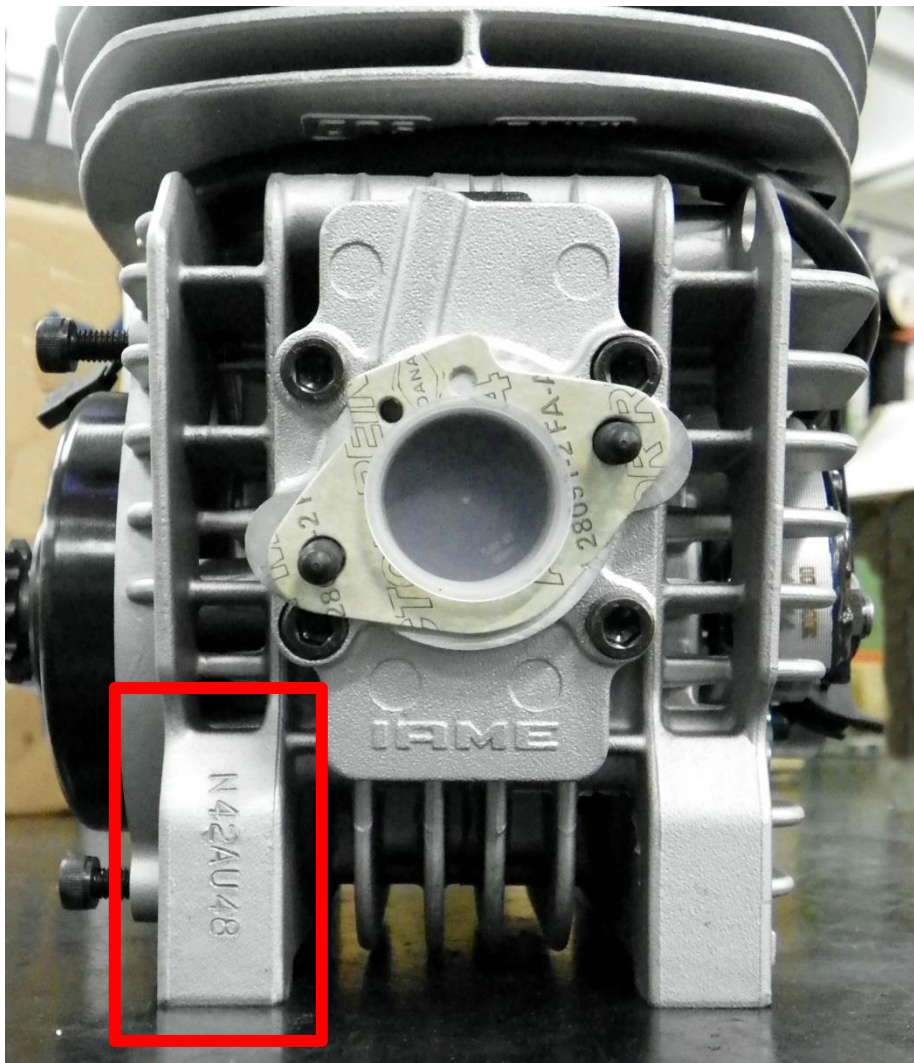

## 2- PREPARATION AND INSTALLATION OF THE ENGINE ON THE CHASSIS

### NOTE:

*In case the engine is supplied already assembled on the chassis, it is at care of the assembler to follow these instructions. The final customer, in this case, can skip this section and can start reading from section 4. Whenever the engine or a component is disassembled, it is necessary to always follow the under shown instructions for proper reassembly.*

### 2.1- INSTALLATION SKETCH OF THE ENGINE ON THE CHASSIS

#### NOTE:

BEFORE INSTALLING THE ENGINE ON THE CHASSIS, CHECK THAT BOTH THE HEAD NUTS AND HEAD COLUMN NUTS ARE PROPERLY TIGHTENED, ACCORDING TO THE TORQUE VALUES IN THE TABLE.

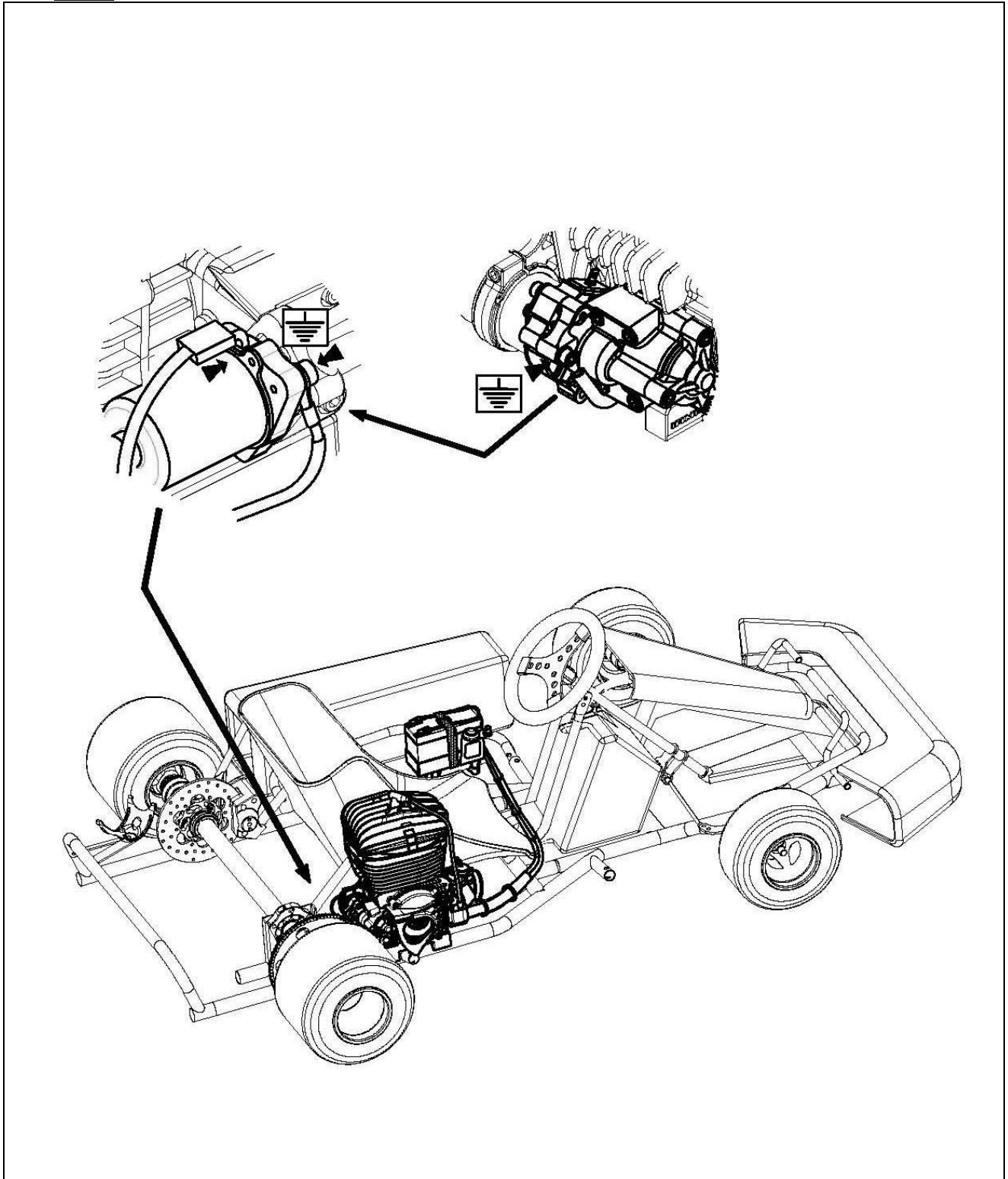

## 2.2- EXHAUST MANIFOLD INSTALLATION

**NOTE:**  
*THE ENGINE IS SUPPLIED WITH AN EXHAUST CARD BOARD COVER TO PROTECT THE INTERNAL PARTS.  
THE EXHAUST GASKET AND STUD BOLTS ARE ALREADY MOUNTED.*

REMOVE THE NUTS AND THE EXHAUST CARD BOARD COVER.

MAKE SURE THAT THE EXHAUST GASKET IS IN SEAT AND INSTALL THE EXHAUST MANIFOLD.

(SEE FIG. 1)

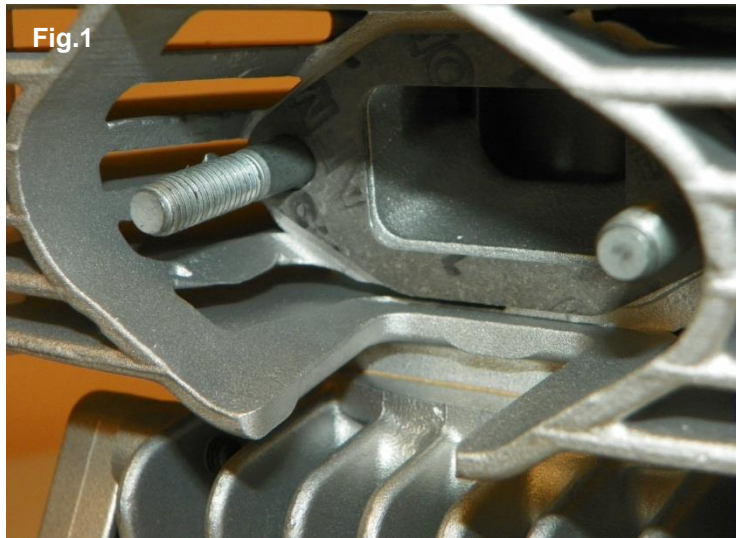

INSERT THE 2 SPRING WASHERS 8mm

**SUGGESTION:**  
**PUT THE ENGINE IN HORIZONTAL POSITION AND PLACE THE SPRING WASHERS IN THEIR SEAT. HELP YOURSELF WITH A SCREWDRIVER.**



INSTALL 2 COLOMN NUTS.  
TIGHTEN TO  $18 \div 22$  Nm.

**SUGGESTION:**  
**EASIER TIGHTENING (as per Fig. 2) WITH A REDUCED EXTERNAL DIAMETER SOCKET WRENCH OR WITH AN OPEN WRENCH.**

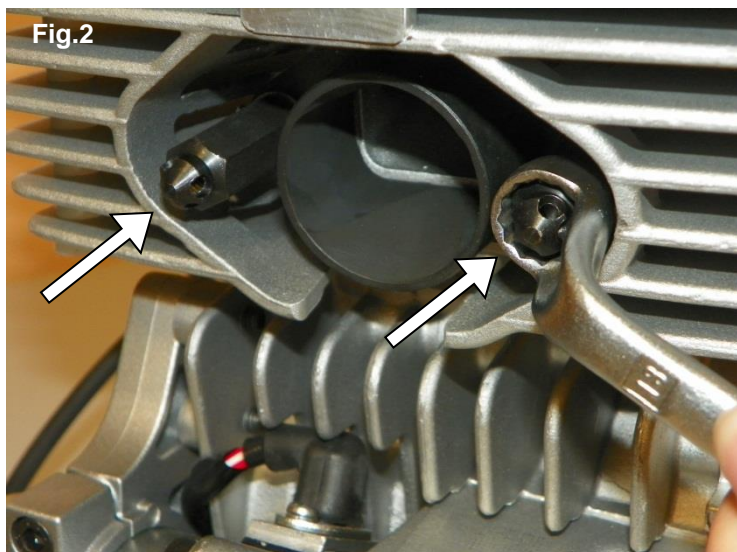
12 POINT ELBOWED WRENCH 13 mm (or 13mm OPEN WRENCH)



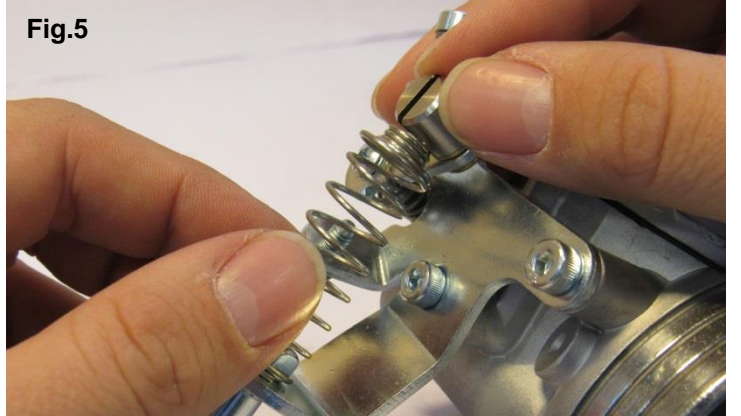
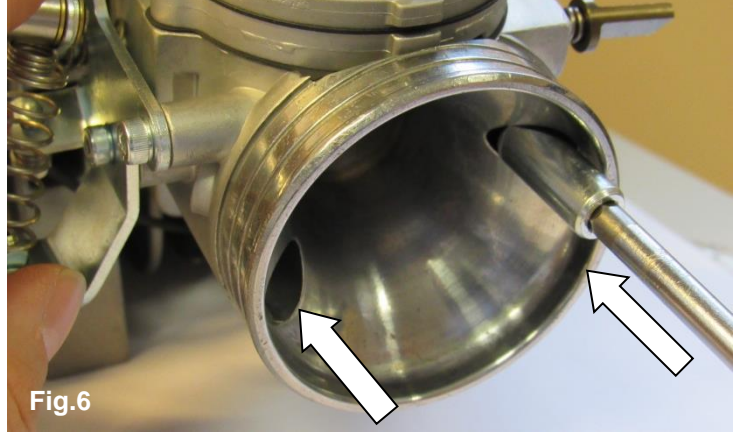

<p><b>2.3- INSTALLATION CARBURETTOR</b></p> <p>INSTALL THE GAS CABLE CLAMP ON THE SUPPORT</p> <p>(SEE FIG. 3)</p>	<p>12 POINT WRENCH 10mm</p> <p><b>Fig.3</b></p> 
<p>TIGHTEN NUT M6 WITH 12 PONT WRENCH 10mm.</p> <p>(SEE FIG. 4)</p>	<p><b>Fig.4</b></p> 
<p>POSITION THE SPRING ON THE LEVER.</p> <p>(SEE FIG. 5)</p>	<p><b>Fig.5</b></p> 
<p><b>POSITIONING CARBURETTOR:</b></p> <ul style="list-style-type: none"> <li>• REMOVE THE PLASTIC PROTECTION PLUG</li> <li>• LEAVE THE GASKET ON THE ENGINE AND INSTALL IN THIS WAY (SEE FIG.6) CARBURETTOR</li> </ul> <p>TIGHTEN THE CARBURETTOR COLUMNS NUT M6 AT <math>6 \div 8</math> Nm, WITH A 5mm ALLEN WRENCH T-TYPE.</p>	<p><b>Fig.6</b></p> 

FINAL STEP - AFTER THE COMPLETE INSTALLATION OF THE ENGINE ON THE CHASSIS.

CONNECT THE FUEL FEED HOSE TO THE INLET FITTING ON THE CARBURETTOR CAP.

(SEE FIG. 7)

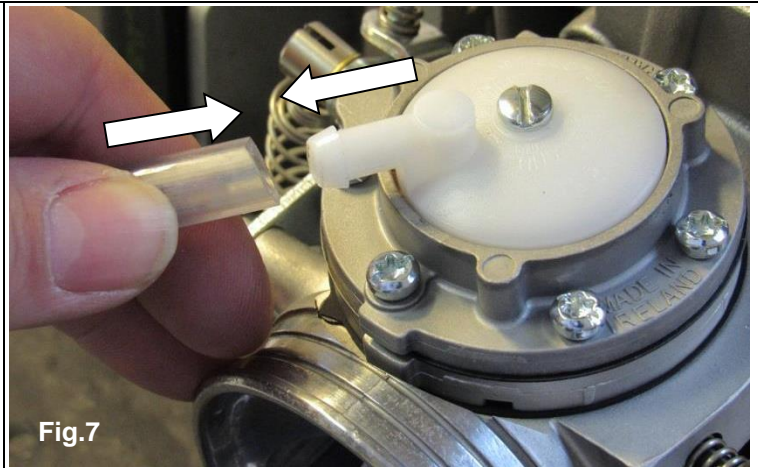
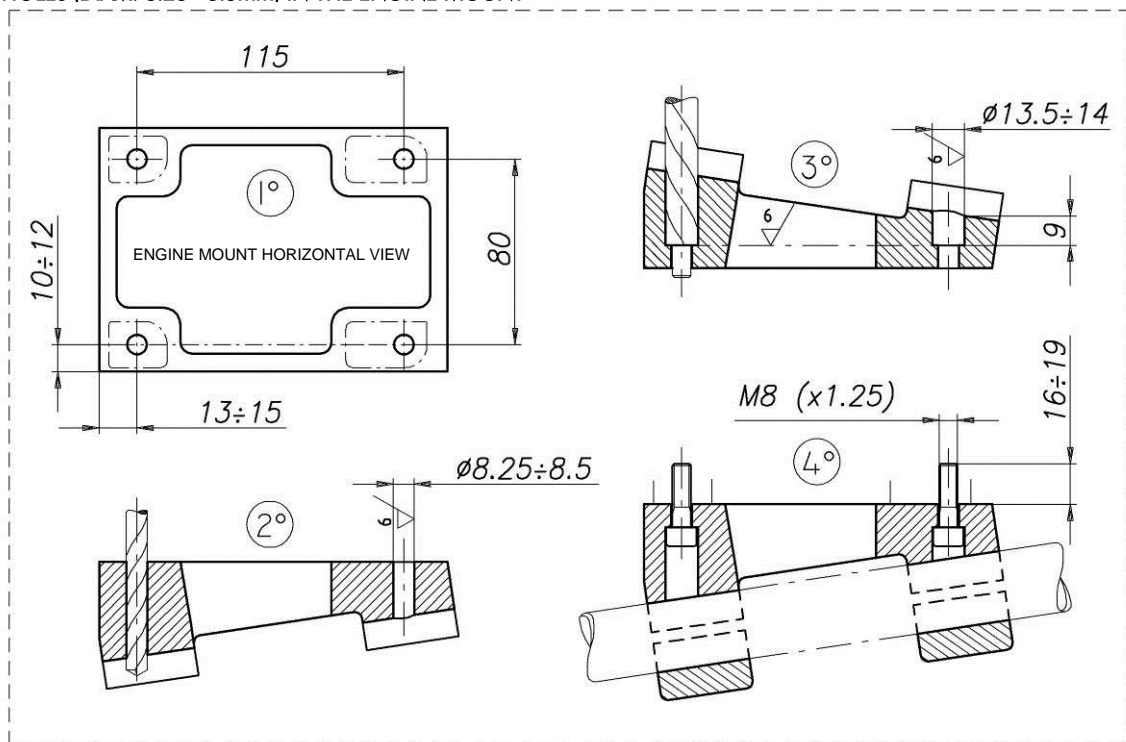

Fig.7

## 2.4- PREPARATION AND INSTALLATION OF THE ENGINE-MOUNT

*NOTE: ALL THE DIMENSIONS IN MILLIMETERS*

DRILL 4 HOLES (DIAM.  $8.25 \pm 8.5$ mm) IN THE ENGINE-MOUNT



**2.5 INSTALL THE ENGINE ON THE CHASSIS**

POSITION THE ENGINE ON THE 2 OUTSIDE MAIN RAILS AND FIX THE MOTOR-MOUNT WITH THE TWO CLAMPS.

(SEE FIG.11)

**SUGGESTION:**  
NEVER TORQUE COMPLETELY THE CLAMPS UNTIL THE CHAIN IS INSTALLED AND PROPERLY ALIGNED.



Fig.11

CHECK THE ALIGNMENT OF THE ENGINE SPROCKET AND THE AXLE SPROCKET WITH A STRAIGHT EDGE.

(SEE FIG. 12)

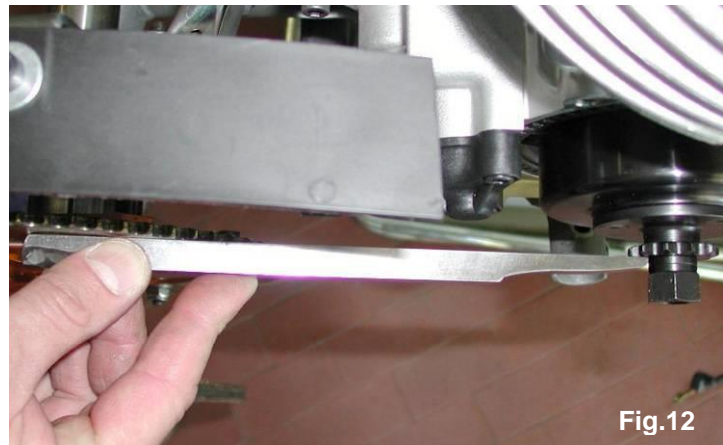

Fig.12

INSTALL THE CHAIN (PITCH: #219).

(SEE FIG. 13)



Fig.13

MOVE THE ENGINE ON THE RAILS TO ADJUST THE CHAIN TENSION.

**⚠ ATTENTION:**  
THE PLAY OF THE CHAIN MUST BE APPR. 16mm (1/2 ÷ 3/4 inch) MEASURED IN THE SHOWN POINT.

(SEE FIG. 14)

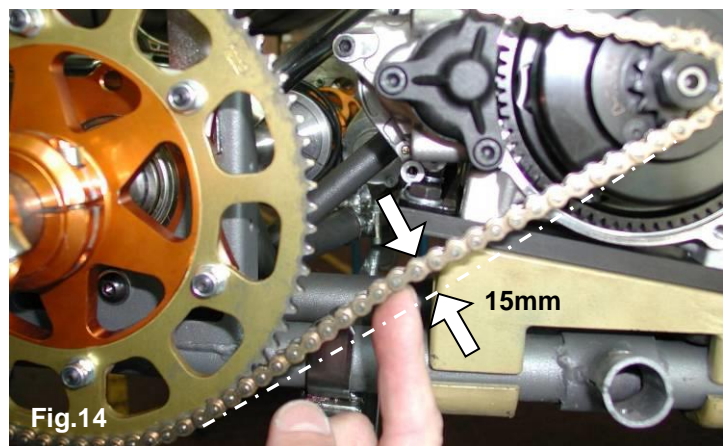

Fig.14

COMPLETELY TIGHTEN THE ENGINE MOUNT SCREWS.

**2.6 INSTALL THE CLUTCH COVER WITH H.T. COIL**

REMOVED THE 3 SCREWS TCEI M6x30 FROM THE CRANKCASE (SEE FIG. 15) AND INSTALL THE CLUTCH COVER WITH THE H.T. COIL.

(SEE FIG.16)

TIGHTEN THE 3 SCREW AT  $8 \div 10$  Nm



**ATTENTION:**  
ALWAYS MAKE SURE THAT THE GROUND CABLE ALWAYS CONNECTS THE COIL WITH THE ENGINE. AN INADEQUATE GROUNDING COULD DAMAGE THE IGNITION BEYOND REPAIR.

THE POSITION OF THE H.T. COIL HAS BEEN CHOSEN TO BE AS FAR AS POSSIBLE FROM THE EXHAUST AS THE EXCESSIVE HEAT COULD DAMAGE THE COIL BEYOND REPAIR.

ALLEN WRENCH 5 mm

**Fig.15**

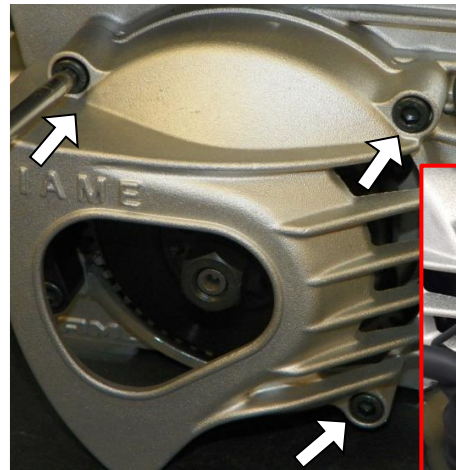
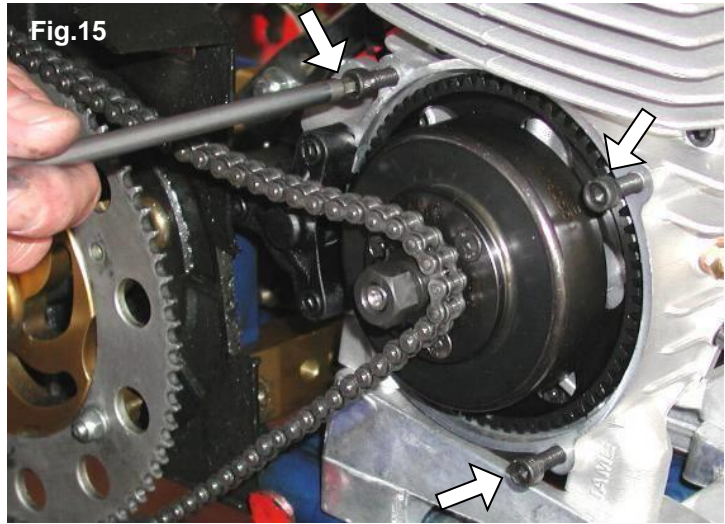

## 2.7- ELECTRICAL CONNECTIONS

(refer to the attached electrical scheme)

**NOTE:**

FOR A CORRECT INSTALLATION FOLLOW THE UNDER SHOWN INSTRUCTIONS.

INSERT BATTERY FIXING STRIPE IN THE DEDICATED SLOTS.

(SEE FIG. 17)

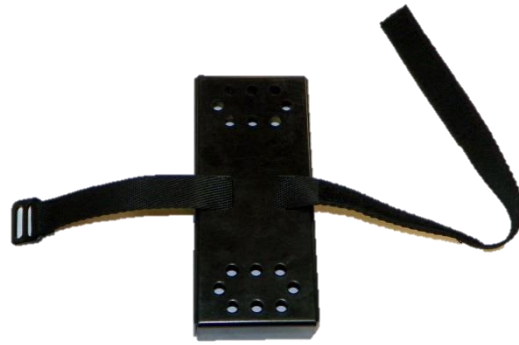

Fig.17

PLACE THE BATTERY SUPPORT CLAMPS ON THE CHASSIS TUBE, FIX THEM THROUGH THE SPECIFIC SCREWS ON THE SUPPORT PIPES (SCREW TE M6x25 – SEE FIG. 18). JUST TIGHTEN A LITTLE TO KEEP THEM IN PLACE ON THE CHASSIS.

(HEXAGONAL MALE KEY 5mm)

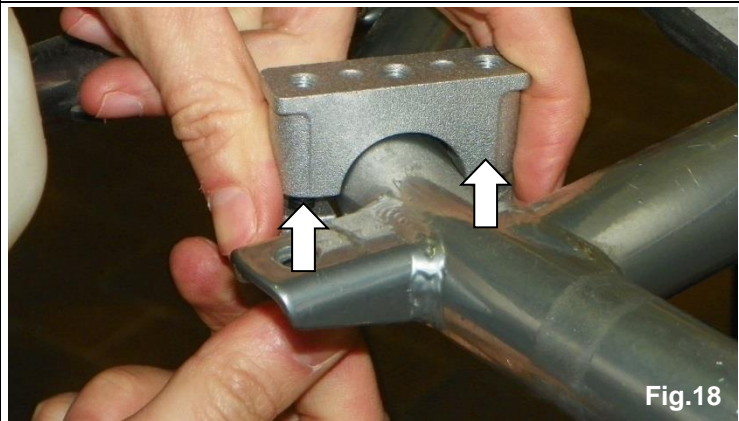

Fig.18

PLACE THE BATTERY SUPPORT, THE PUSH BUTTONS BRACKET BETWEEN THE CLAMP AND THE BATTERY SUPPORT, (SEE FIG. 19), THEN TIGHTEN THE COMPONENTS WITH A 10mm SOCKET WRENCH.

AFTER TIGHTENING THE BATTERY SUPPORT UPPER SCREW, COMPLETELY TIGHTEN ALSO THE CLAMPS SCREWS.

(SOCKET WRENCH 10mm)

**TORQUE THE SCREWS AT 8 ÷ 10 Nm**

(ALLEN WRENCH 5mm)

**TORQUE THE SCREWS AT 8 ÷ 10 Nm**

(SEE FIG. 19 and 20)

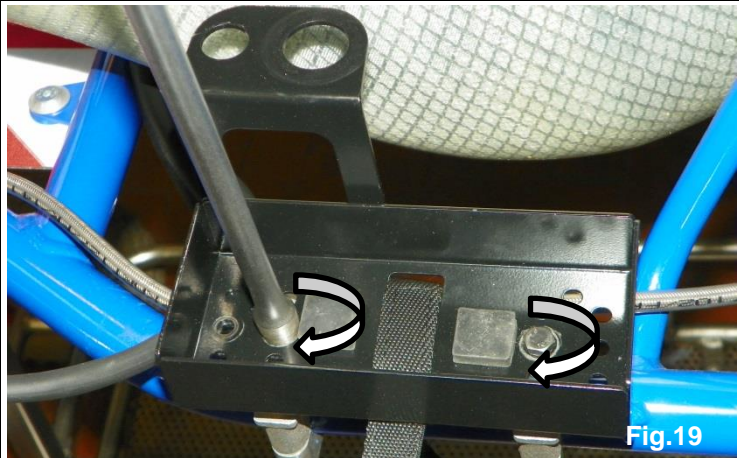

Fig.19

THE BOX MUST BE FIXED WITH AT LEAST ONE SCREW FOR EACH CLAMP.

FIX WITH MORE SCREWS DEPENDING ON CHASSIS.

**NOTE:**

THE DIFFERENT HOLES ON THE BATTERY SUPPORT AND ON THE BRACKET, ALLOW TO ADAPT THE SYSTEM TO EVERY CHASSIS.

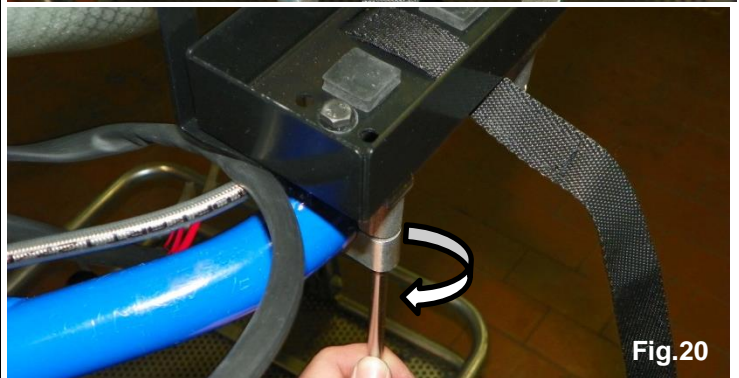
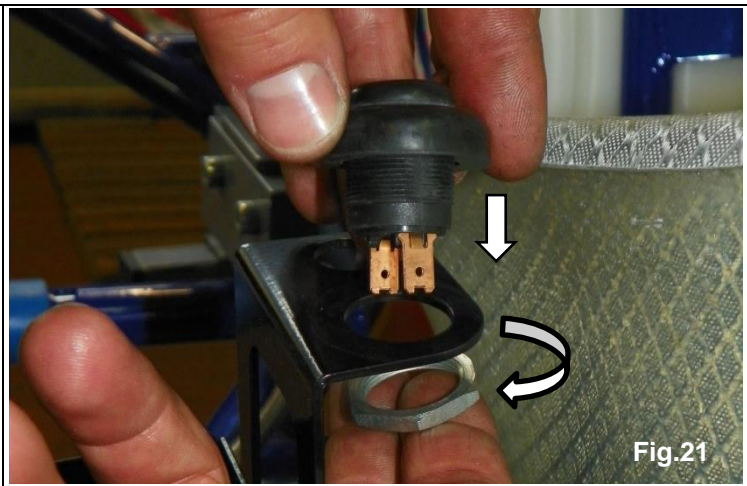

Fig.20

PLACE THE STARTER BUTTON IN THE PROPER HOUSING AND FIX IT THROUGH THE PROVIDED NUT.

(SEE FIG.21)

FIX AND PLACE THE BUTTON WITH THE FASTON ORIENTED AS IN THE FIGURE:



PASS THE CABLE WITH THE BUTTONS TERMINALS IN THE BRACKET, CONNECT THE 2 FASTONS TO THE STARTER BUTTON AND TIGHTEN THE STOP RED BUTTON WITH THE PROVIDED NUT (SEE FIG. 22).

**NOTE:**  
THE 2 START BUTTON FASTONS CAN BE INVERTED. THIS DOES NOT CAUSE WORKING PROBLEMS.

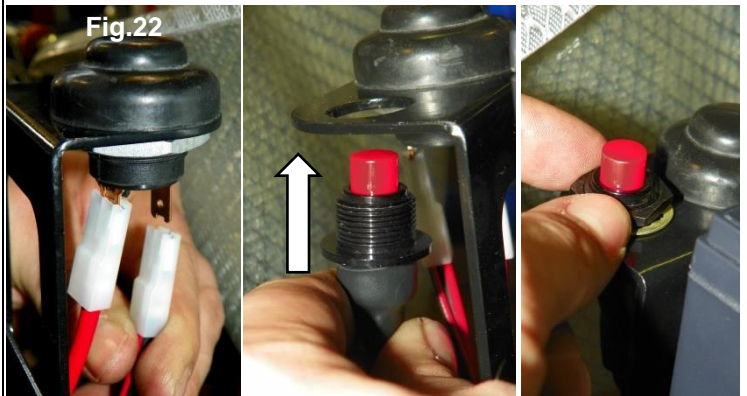

CONNECT THE BATTERY CABLES TO THE FASTONS AND TIGHTEN THE STRAP ON THE CABLES.

(SEE FIG. 23)



CONNECT THE STARTER MOTOR CABLE TO THE CONNECTOR OF THE CABLES ADAPTER.

(SEE FIG.24)

 **ATTENTION:**  
MAKE SURE THAT THE LOCKING OF THE TWO CONNECTORS IS MADE PROPERLY TO ENSURE THE GOOD CONTACT OF THE TERMINALS.

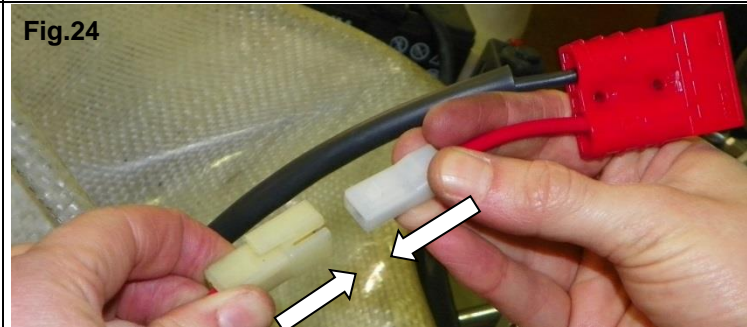

CONNECT THE ADAPTER TO THE CABLES CONNECTOR.

(SEE FIG.25)

THE 2ND ADAPTER TERMINAL MUST BE CONNECTED TO THE GROUND.

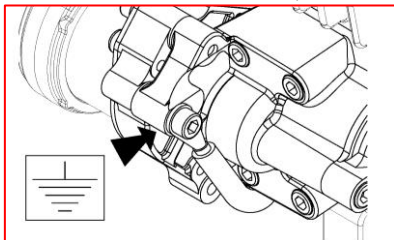

FIX THE KIT CABLES THROUGH A STRAP ACCORDING TO THE CHASSIS AND THE NEED.

(SEE FIG.26)

**Fig.26**



CONNECT THE SUPERSEAL 4 WAYS MALE FASTON CONNECTOR TO THE FEMALE CONNECTOR OF THE STOP CABLE.

(SEE FIG.27)

**Fig.27**



CONNECT THE MALE FASTON OF THE STOP CABLE TO THE FEMALE FASTON CONNECTOR OF THE IGNITION.

(SEE FIG. 28)

**Fig.28**

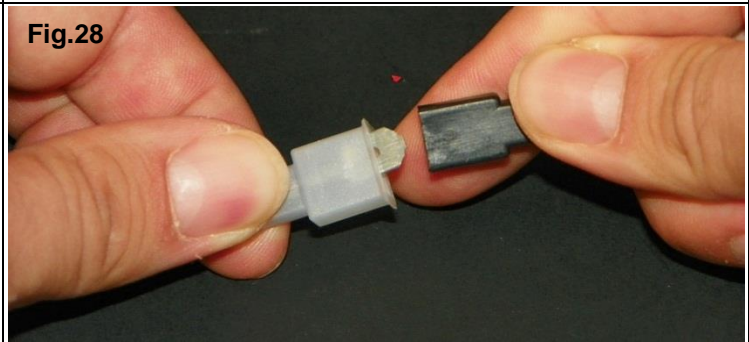

CONNECT THE FEMALE FASTON OF THE IGNITION CABLE ON THE H.T. MALE FASTON.

(SEE FIG.29)

**Fig.29**



SCREW THE SPARK PLUG CAP ON THE COIL HIGH VOLTAGE CABLE.

(SEE FIG. 30)

**Fig.30**



FIX THE CUP ON THE A.T. CABLE THROUGH A PLASTIC STRAP (SEE FIG. 31).

- MOUNT THE SPARK PLUG PROVIDED WITH THE ENGINE  
**TORQUE AT 20 ± 26 Nm**
- ASSEMBLY THE CUP ON THE SPARK PLUG.

**Fig.31**



Caution should be taken when installing the spark plug. Always clean and inspect the spark plug threads before installation. Always apply anti seize compound, grease or oil.

**- NEVER INSTALL THE SPARK PLUG WITHOUT SOME LUBRICATION -**

You should be able to freely turn the plug into the head using only your fingers to turn the plug. Do not force the plug with a tool or damage will occur. After rotating the plug into the head by hand only. Torque to 175-230 lbs-in (20±26 Nm).

## 2.8 ASSEMBLY OF THE INLET SILENCER

MAKE SURE THAT THE INLET SILENCER IS POSITIONED WITH THE HOLES UPSIDE AND THAT THEY ARE NOT OBSTRUCTED.

TIGHTEN THE CLAMP ON THE INLET SILENCER SUPPORT ON THE CARBURETTOR AND FIX THE INLET SILENCER WITH THE DEDICATED CLAMP ON THE CHASSIS TUBE.

(SEE FIG. 32-33)

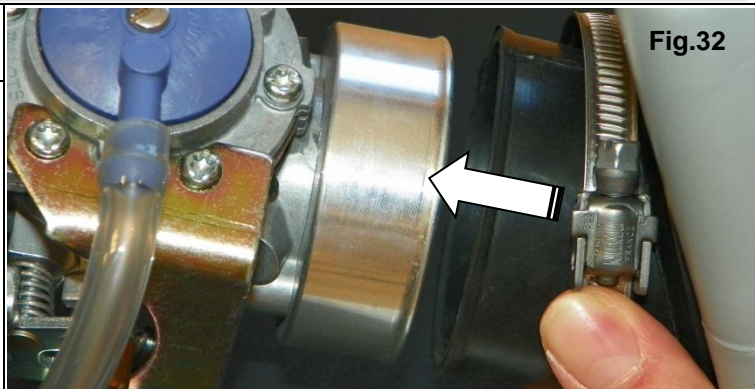

**Fig.32**



**Fig.33**

## 2.9 ASSEMBLY OF THE EXHAUST SYSTEM

ASSEMBLY THE EXHAUST SILENCER ON THE EXHAUST MANIFOLD PREVIOUSLY MOUNTED ON THE CYLINDER AND FIX IT WITH THE PROVIDED SPECIFIC SPRINGS.

(SEE FIG.34).

FIX THE SILENCER ON THE CRADLE SUPPORT OF THE CHASSIS.

NOTE:  
SEE SECTION 3.8 FOR THE WARNINGS ON EXHAUST SYSTEM.



**THE ENGINE IS NOW READY TO START**



## 3- ENGINE USE

### 3.1- MIXTURE OIL AND FUEL

Use unleaded Premium gasoline 98 RON (minimum), mixed with oil at 5% (20:1). Please note that castor oils create gummy residues that give origin to carbon deposits causing incrustations, it is necessary to check and clean the piston and the head at least every 5 hours.

Recommended oils :

- WLADOIL RACING K2T
- ELF HTX 976

Once the tank has been filled, make sure that the fuel flows to the carburettor before starting the engine.

Avoid pump fuel to the carburettor by operating the electric starter, as it causes a useless battery discharge.

#### SUGGESTION:

Remove the fuel tube on the carburettor and the breather pipe of the recovery tank breather and blow into the breather pipe till the fuel comes out from the tube on the carburettor. Make sure that there are no air bubbles into the tube. Connect the tube on the carburetor and on the breather.

### 3.2- CARBURETTOR SETTING

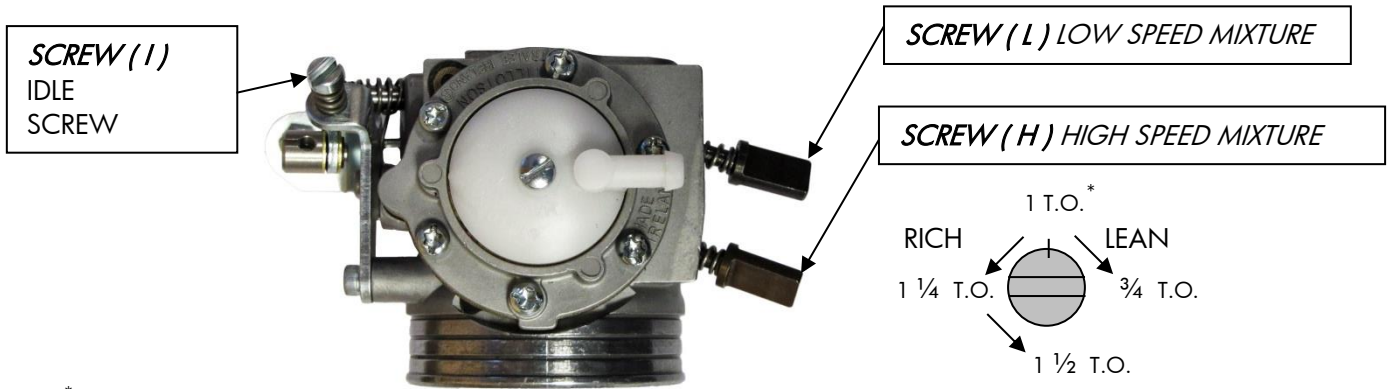

\* T.O. = TURNS OPEN

Generally the correct setting of the carburettor screws is the following:

- L (close the screw completely and then open): 1 T.O.
- H (close the screw completely and then open): 1 T.O.

According to various factors as altitude and environmental temperature, it might be necessary to adjust the carburettor settings to optimize the engine performance.

**! ATTENTION :**

- Never lean excessively the mixture, the engine may overheat and seize up
- Never force the screws H and L completely. This may damage the screws housing and make the carburetor unusable.
- The carburettor setting must be made on warm engine.

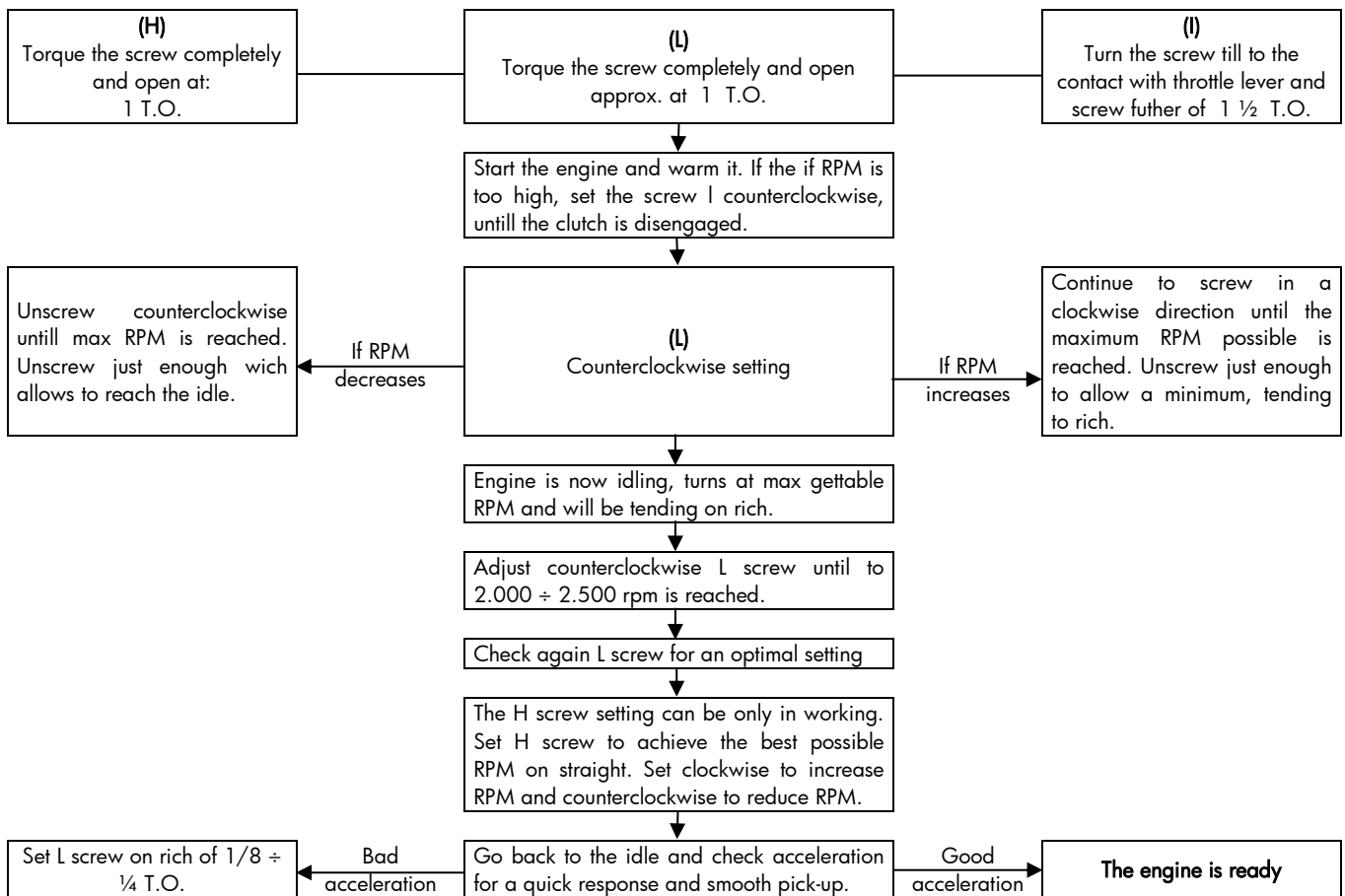

### 3.3- STARTING AND STOPPING THE ENGINE

The engine start is achieved by pushing the black rubber button on the bracket.

If the engine does not start, stop and try again.

If the engine does not start within 5 seconds (check that gasoline flows to the carburettor), stop the procedure and try after about 15 seconds. Short and frequent tries are better than long ones.

In case the engine can't be started, refer to the Sec. 3.15 "Troubleshooting".

Stop the engine by pressing the red button on the bracket.

Keep the stop button pressed until the engine is completely stopped.

### 3.4- ENGINE RUNNING-IN

The running-in must be made following a few basic rules:

1. Carburation setting. Start with basic setting on the rich side.
2. Warm the engine gradually for 5 minutes, driving some laps at low speed, smoothly closing and opening the accelerator (if a tachometer is installed, never exceed 9.000 ÷ 10.000 RPM). **Never keep the same RPM for a long time but alternate the speed.**
3. Gradually increase the vehicle speed for about 5 minutes (with  $\frac{3}{4}$  throttle opening). **Never keep the same RPM for a long time but to alternate it.**
4. Increase the speed driving some laps, for about 5 minutes (with accelerator fully opened on circuit twisty parts and enrich the carburation at half straight (cover with the hand the inlet hole on the inlet silencer for an instant, keeping the throttle open).



#### **WARNING:**

**Very important, when the engine is cold, check the tightening of the cylinder head nuts after the first hour of use, according to the torque table to the of this manual.**

**Once the running-in is over, with cold engine, check the tightening of the exhaust pipe nuts as during the 1st running-in, the nuts can get loose (refer to the attached table).**

### 3.5- INLET SILENCER

Make sure that the inlet holes of the inlet silencer are towards the upper side and they are not covered. Make sure that the fixing straps are not loosened and that the inlet silencer is well fastened to the chassis through the specific strap.

Occasionally, check the presence of oil deposits in the inlet silencer. If necessary, remove the manifold with filter and clean the inside with gasoline or a diluent.

### 3.6- EXHAUST SYSTEM WARNINGS

Make sure that the silencer fixing springs are well hooked. In case of damage replace the broken springs. Never race the kart without the two springs well hooked, as the silencer becomes dislodged.

It is recommended to open the exhaust pipe end every 10 ÷ 15 hours and make sure that the holes on the counter cone are not obstructed by incrustation.

### 3.7- EXHAUST GAS TEMPERATURE PROBE

The exhaust muffler is not provided with a temperature probe lodgment. If necessary, it is possible to install the probe support and as indicated in the figure. Whenever you wish to employ the probe, please proceed as shown in the figure below.

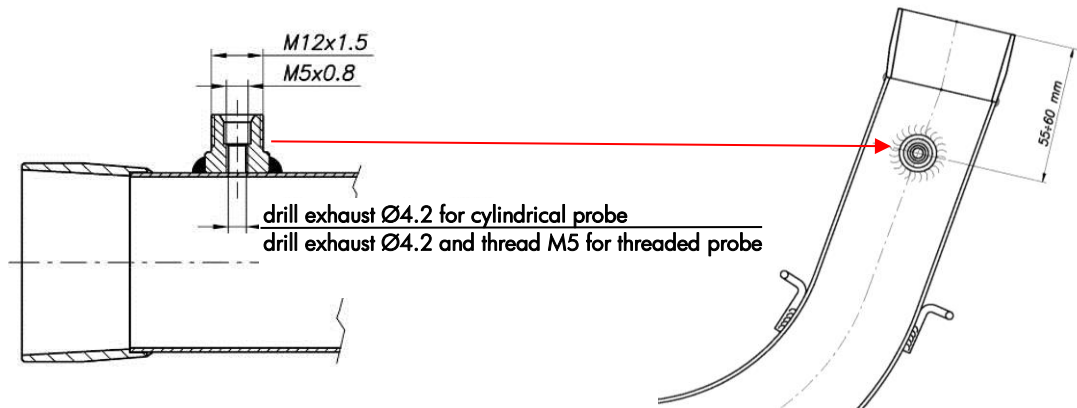

### 3.8- CENTRIFUGAL CLUTCH

The engine has a low maintenance dry centrifugal clutch. The following prescriptions, if carefully followed, will allow a clutch longlife.

When starting the engine, make sure that the brake pedal is fully pressed to avoid any sudden accelerations.

**! WARNING:**

Once the engine is started, absolutely avoid useless accelerations (glazed of the friction and/or skids) which can overheat and deteriorate the clutch group before time. Grease the chain before each session. Check the engine sprocket, after each test or race and replace it, if necessary. A bad alignment of the engine sprocket with the axle sprocket or chain grease lack can irreparably damage the sprocket.

When it is necessary to check the clutch?:

- Every 5 hours of standard use.
- When metallic noises from the clutch are heard.
- If the kart dragging speed exceeds 6.000 RPM.
- When the clutch has overheated (presence of smoke or smell of burning).

Remove the clutch cover and the clutch drum to check the clutch.

When it is necessary to replace the clutch?:

- whenever the thickness of the friction material is lower than 1.5mm on "point A" of the picture, if the body diameter is lower than 83mm, or when is very rough (wear and deterioration of the friction material due to overheating).

**! WARNING:**

In case the friction material is fully worn out and there has been a prolonged contact between the clutch body and clutch drum, it also necessary to replace the clutch drum.

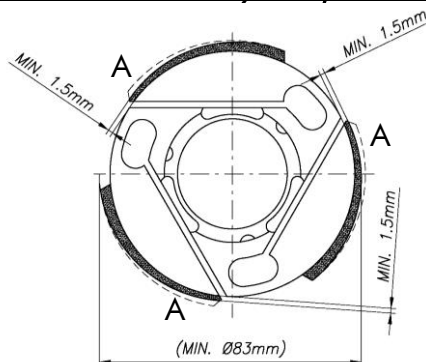

### 3.9- INSTRUCTIONS FOR THE DISASSEMBLY / ASSEMBLY OF THE CLUTCH GROUP

**! WARNING :**



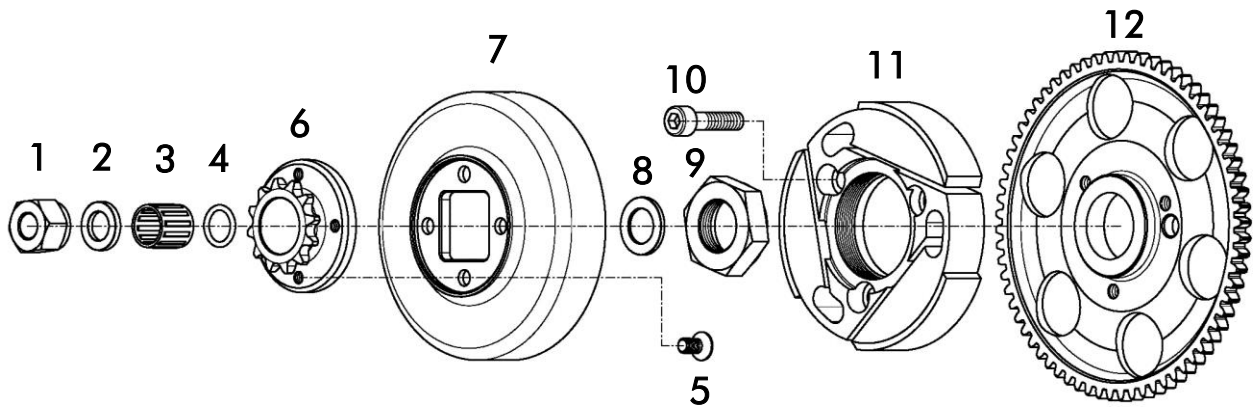

*The following operations can be made by a skilled mechanic, with the proper tools shown in the text ; otherwise, it is necessary to apply to an Authorized Service Center. Refer to the following drawing during the different operations.*



- |                      |                   |                  |
|----------------------|-------------------|------------------|
| 1 Drum retaining nut | 6 Sprocket        | 11 Clutch body   |
| 2 External washer    | 7 Clutch drum     | 12 Starter wheel |
| 3 Roller cage        | 8 Internal washer |                  |
| 4 O Ring             | 9 Locking nut     |                  |
| 5 Screw              | 10 Screw          |                  |

OPERATIONS	TOOLS
<b>Clutch disassembly</b>	
1. Remove the clutch cover (3 screws TCEI M6).	▪ Allen wrench 5mm male – T type
2. Remove the bendix cover and place the starter wheel locking tool.	▪ Starter wheel locking tool : ATT.037
3. Remove the retainer nut. (N°1 - M10 nut)	▪ Ring wrench 17 mm
4. Remove the external washer, the complete drum with roller cage, the internal washer.	
5. With the starter wheel locking tool in place, remove the M20x1 clutch hub nut.	▪ Starter wheel locking tool: ATT.037 ▪ Allen wrench 27 mm
<b>! WARNING:</b> <i>Unscrew clockwise as the nut has left-hand thread</i>	
6. Remove the clutch hub and the starter wheel from the crankshaft through clutch puller.	▪ Clutch puller : ATT.026 ▪ Allen wrench 12mm male
7. Remove the starter wheel (3 screws M6 TCEI)	▪ Allen wrench 5mm male – T type

Before assembling the clutch, wash with the diluent : the shaft cone, the starter wheel and the clutch drum.

<u>Clutch assembly</u>	
<p>1. Assemble the starter wheel on the clutch hub by matching the 3 holes and the dragging pin (3 screws TCEI M6)</p> <p> <b>WARNING:</b> <i>it is necessary to always install the Ø7mm pin, as eventual kicks could shear the screws.</i></p>	<ul style="list-style-type: none"> <li>▪ Allen wrench 5mm male – T type</li> <li>▪ (torque at 10÷12 Nm)</li> <li>▪ Apply “Loctite” threadlocker</li> </ul>
<p>2. Place the clutch hub and the starter wheel on the shaft.</p>	<ul style="list-style-type: none"> <li>▪ Apply “Loctite 641” for coaxial locking.</li> </ul>
<p>3. Assemble the fixing nut, clutch hub and starter wheel, through the starter wheel locking tool and the allen wrench 27mm.</p> <p> <b>WARNING:</b> <i>Screw counter-clockwise as the nut has left-hand thread.</i></p>	<ul style="list-style-type: none"> <li>▪ Starter wheel locking tool : ATT.037</li> <li>▪ Allen wrench 27 mm. (torque at 100 ÷ 110 Nm)</li> </ul>
<p>4. Assemble the internal washer.</p> <p> <b>WARNING:</b> <i>the bevel of the washer hole must be towards the shaft.</i> Clean the roller cage and grease it before assembling it on the shaft.</p>	
<p>5. Mount the clutch drum and the external washer.</p> <p> <b>WARNING:</b> <i>the bevel of the washer hole must be towards the shaft.</i></p>	
<p>6. With the starter wheel locking tool in place, tighten the drum retainer nut (nut M10).</p>	<ul style="list-style-type: none"> <li>▪ Starter wheel locking tool: ATT.037</li> <li>▪ Ring wrench 17 mm (torque at 30 ÷ 40 Nm)</li> </ul>
<p>7. Reassemble the clutch cover (3 screws TCEI M6)</p>	<ul style="list-style-type: none"> <li>▪ Allen wrench 5mm male – T type (torque at 8 ÷ 10 Nm)</li> </ul>

### 3.10 BATTERY

The battery (12V – 9Ah) is sealed and without maintenance.

In order to prolong the battery life, it is recommended to follow these few prescriptions:

- When the tension drops below 12.6V, it is necessary to recharge the battery.
- The max allowed recharging current is 1.8A.
- The ideal recharge is achieved with an average current of 0.8÷1A. (recharging time of approx 10 h.) at an environmental temperature between 0° e 40°C.

 **WARNING:**

**An overcharge or an extremely quick charge with excessive current can damage the battery components (battery swelling).**

Choose a battery charger with the following characteristics :

- Feeding tension : 90/250 Vac – 50/60 Hz
- Outlet tension : 15 V full charge – 13.8 stand-by
- Max outlet current : 2A full charge
- During the transport and/or the storage, the battery could lose part of its charge due to the self-discharge (0.1% max. per day).

Fully charge the battery before use.

 **WARNING:**

**Always connect the + (positive) pole before the - (negative) pole.**

**Always disconnect the battery in opposite order.**

- Recharge the battery at least once every 6 months

- Never let the battery tension drop under 8V as under this limit the battery can not be used and it will have to be replaced.
- Never put the battery in contact with solvents, oils, plastifiers or rags containing such elements as the battery external case could be damaged.
- Never press and/or bend or overheat the battery terminals (for ex. by welding).

#### Other recommendations



- Avoid the generation of sparks or flames upon or around the battery.
- Never short-circuit the terminals.
- Never open the battery or throw in the fire
- In case the electrolyte (diluted Sulfuric Acid) gets in contact with skin or clothes, wash immediately with water. In case it gets in touch with eyes, wash and apply for medical assistance.
- Carefully check the external battery case and replace it in case of damages, swellings of the case or the battery cover.
- Before use, clean the battery from dust or other dirt and check that the poles are not oxydized or damaged.
- At the end of the battery life, never throw it in the garbage but deliver it to an authorized waste disposer.

### 3.11- SPARK PLUG AND THERMAL DEGREE

The engine is supplied with a standard **NGK BR10EG** spark plug. It represents a good compromise between the need of a good running-in and the racing needs in standard conditions.

The use of different spark plugs is possible and, as a general information, we are attaching a correspondence list among several brands, according to the thermal degree which represents the capacity of the spark plug to dissipate the inside heat. The colour of the various parts of the spark plug more exposed to the combustion flames gives a good indication of the suitability of the thermal degree and on the carburetion. It is necessary though to understand which of the two parameters has to be modified and only tells how to identify the spark plug with a most suitable thermal degree, as lean or rich mixtures can generate the same final look which can also be achieved with spark plugs respectively too hot or too cold.

See the table for information purposes :

<p>A spark plug too hot shows the symptoms aside listed.</p> <p> <b>WARNING:</b> <u><i>employ a spark plug too hot than a standard one, with cold or rainy weather.</i></u></p>	<ul style="list-style-type: none"> <li>▪ Extremely clear colour, porous and calcified look of the electrodes and of the internal insulation.</li> <li>▪ Ignition irregularity, preignition and detonation with tendency to perforate the top of the piston.</li> <li>▪ <b>Note:</b> <i>some of these symptoms can be achieved with lean mixtures.</i></li> </ul>
<p>A spark plug with suitable thermal degree shows:</p>	<ul style="list-style-type: none"> <li>▪ Shade colour, from the insulator end and of the electrode, from yellow grey till to dark brown for mixture respectively lean or rich.</li> </ul>
<p>A spark plug too cold shows the symptoms aside listed.</p> <p> <b>WARNING:</b> <u><i>employ a spark plug too cold than a standard one, with very hot weather</i></u></p>	<ul style="list-style-type: none"> <li>▪ Insulator end and electrodes covered by black matt soot</li> <li>▪ Ignition difficulties.</li> <li>▪ <b>Note:</b> <i>a wet or oily electrode could also mean a too rich mixture.</i></li> </ul>

## INDICATIVE SPARK PLUG COMPARISON TABLE

### BASED ON THERMAL DEGREE

HOT ↑		
BOSCH	NGK	CHAMPION
WO8CS	BR9EG	N54R
WO7CS	BR10EG	N52R
WO6CS	BR11EG	
↓ COLD		

### 3.12- CHOICE OF THE SPROCKETS RATIO

The life of an engine depends upon many factors but most of all upon the speed at which the engine is operated. If an engine is normally operated at speeds higher than what recommended by the manufacturer, the wear and stress of the different components (con-rods, roller cages, bearings etc.) will be such as to drastically reduce the life of the engine itself. It is therefore extremely important that the user respects the operating limits imposed by the manufacturer.

The operating limit for the Reedjet 100cc engine is 15.000 RPM.

#### **ATTENTION:**

**Never exceed the above limit. No obligation of IAME exists in case the above limit is exceed.**

In case the user wishes to optimize the sprocket ratio on the track, in order to achieve the best possible performance and without overloading the engine, follow the under shown recommendations.

The engines are supplied with a 10,11,12 or 13 teeth sprocket (pitch: #219).

Table 1 shows the various ratios between the sprocket on the axle and the engine sprocket given the different axle sprockets.

Tab.1

Sprocket Ratio	Teeth n° - Engine sprocket				Sprocket Ratio	Teeth n° - Engine sprocket			
Starting Gear	10	11	12	13	Teeth n° Axle Gear	10	11	12	13
72	7,2	6,55	6,00	5,54	83	8,3	7,55	6,92	6,38
73	7,3	6,64	6,08	5,62	84	8,4	7,64	7,00	6,46
74	7,4	6,73	6,17	5,69	85	8,5	7,73	7,08	6,54
75	7,5	6,82	6,25	5,77	86	8,6	7,82	7,17	6,62
76	7,6	6,91	6,33	5,85	87	8,7	7,91	7,25	6,69
77	7,7	7,00	6,42	5,92	88	8,8	8,00	7,33	6,77
78	7,8	7,09	6,50	6,00	89	8,9	8,09	7,42	6,85
79	7,9	7,18	6,58	6,08	90	9	8,18	7,50	6,92
80	8	7,27	6,67	6,15	91	9,1	8,27	7,58	7,00
81	8,1	7,36	6,75	6,23	92	9,2	8,36	7,67	7,08
82	8,2	7,45	6,83	6,31					



For the operation limit of 15.000 RPM the following table (Tab.2) has been prepared

**SUGGESTION:**

- During the track tests the use of a tachometer recording the max obtained engine RPM is recommended.
- Use spark plug caps with a resistance of 5K $\Omega$  to avoid eventual interferences between the ignition and the tachometer and/or telemetry.







The following example should clarify the procedure for the optimization of the sprocket.

Assume to use the engine with Z=10 teeth engine sprocket and that during the preliminary track tests a Z=72 teeth axle sprocket has been used.

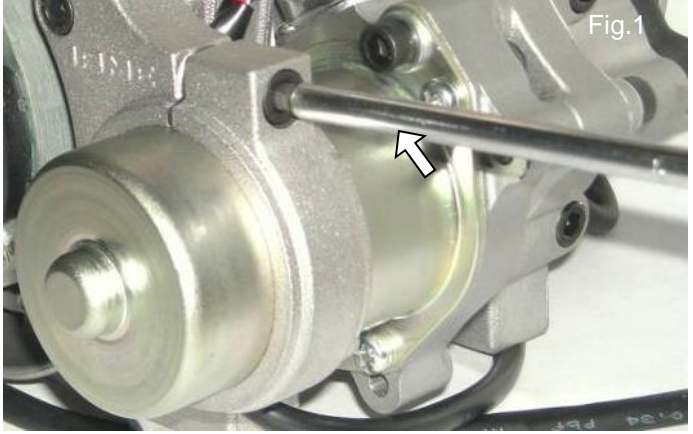
- From table 1 with Z=10 as engine sprocket and Z=72 on the axle sprocket, a ratio of 7.20 is found.
- Make a few laps on the track and let's assume you read 15.000 max engine RPM.
- From the table 2 to achieve a max RPM of 15.000 RPM (operating limit for the KA100 engine) a sprocket ratio from 7.61 and 7.82 should be used (having used, during the tests, a sprocket ratio of 7.2 and having achieved 14.000 RPM max.).
- From table.1, with these values, a sprocket ratio of 10:76 / 10:78 should be used or, having a Z=11 on the engine sprocket, a ratio 11:85 should be used.

Sprocket ratio to achieve max 15000 RPM														Tab. 2	
Engine max RPM during tests	Sprocket ratio														
	6,5	6,7	6,9	7,1	7,3	7,5	7,7	7,9	8,1	8,3	8,5	8,7	8,9	9,1	9,3
13000	7,50	7,73	7,96	8,19	8,42	8,65	8,88	9,12	9,35	9,58	9,81	10,04	10,27	10,50	10,73
13200	7,39	7,61	7,84	8,07	8,30	8,52	8,75	8,98	9,20	9,43	9,66	9,89	10,11	10,34	10,57
13400	7,28	7,50	7,72	7,95	8,17	8,40	8,62	8,84	9,07	9,29	9,51	9,74	9,96	10,19	10,41
13600	7,17	7,39	7,61	7,83	8,05	8,27	8,49	8,71	8,93	9,15	9,38	9,60	9,82	10,04	10,26
13800	7,07	7,28	7,50	7,72	7,93	8,15	8,37	8,59	8,80	9,02	9,24	9,46	9,67	9,89	10,11
14000	6,96	7,18	7,39	7,61	7,82	8,04	8,25	8,46	8,68	8,89	9,11	9,32	9,54	9,75	9,96
14200	6,87	7,08	7,29	7,50	7,71	7,92	8,13	8,35	8,56	8,77	8,98	9,19	9,40	9,61	9,82
14400	6,77	6,98	7,19	7,40	7,60	7,81	8,02	8,23	8,44	8,65	8,85	9,06	9,27	9,48	9,69
14600	6,68	6,88	7,09	7,29	7,50	7,71	7,91	8,12	8,32	8,53	8,73	8,94	9,14	9,35	9,55
14800	6,59	6,79	6,99	7,20	7,40	7,60	7,80	8,01	8,21	8,41	8,61	8,82	9,02	9,22	9,43
15000	6,50	6,70	6,90	7,10	7,30	7,50	7,70	7,90	8,10	8,30	8,50	8,70	8,90	9,10	9,30
15200	6,41	6,61	6,81	7,01	7,20	7,40	7,60	7,80	7,99	8,19	8,39	8,59	8,78	8,98	9,18
15400	6,33	6,53	6,72	6,92	7,11	7,31	7,50	7,69	7,89	8,08	8,28	8,47	8,67	8,86	9,06
15600	6,25	6,44	6,63	6,83	7,02	7,21	7,40	7,60	7,79	7,98	8,17	8,37	8,56	8,75	8,94
15800	6,17	6,36	6,55	6,74	6,93	7,12	7,31	7,50	7,69	7,88	8,07	8,26	8,45	8,64	8,83
16000	6,09	6,28	6,47	6,66	6,84	7,03	7,22	7,41	7,59	7,78	7,97	8,16	8,34	8,53	8,72
16200	6,02	6,20	6,39	6,57	6,76	6,94	7,13	7,31	7,50	7,69	7,87	8,06	8,24	8,43	8,61
16400	5,95	6,13	6,31	6,49	6,68	6,86	7,04	7,23	7,41	7,59	7,77	7,96	8,14	8,32	8,51
16600	5,87	6,05	6,23	6,42	6,60	6,78	6,96	7,14	7,32	7,50	7,68	7,86	8,04	8,22	8,40
16800	5,80	5,98	6,16	6,34	6,52	6,70	6,88	7,05	7,23	7,41	7,59	7,77	7,95	8,13	8,30
17000	5,74	5,91	6,09	6,26	6,44	6,62	6,79	6,97	7,15	7,32	7,50	7,68	7,85	8,03	8,21

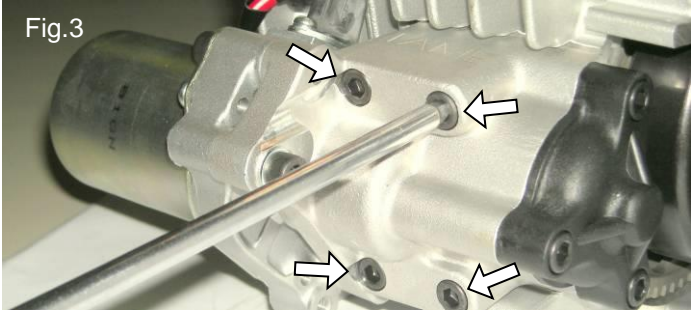
### 3.13- REPLACEMENT OF THE STARTER BRUSHES

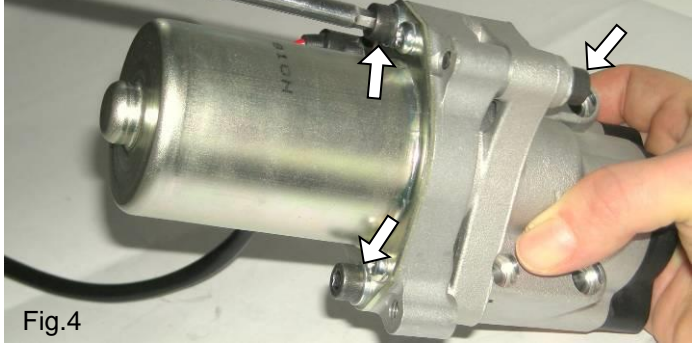
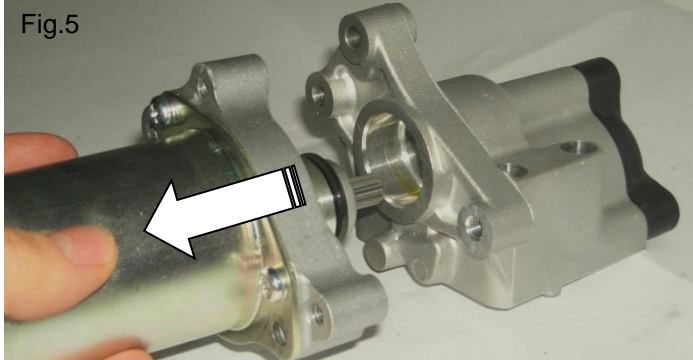
	<u>OPERATIONS</u>	<u>PICTURES</u>
	<p><b>DISASSEMBLE THE STARTER MOTOR</b></p> <p>- LOOSE THE SCREW M6x30 ON THE ADDITIONAL STARTER SUPPORT (See Fig.1).</p> <p>(5mm ALLEN WRENCH T TYPE)</p>	 <p>Fig.1</p>
	<p>- REMOVE THE ADDITIONAL STARTER SUPPORT 3 SCREWS M6x25 (See Fig.2).</p> <p>(5mm ALLEN WRENCH T TYPE)</p>	 <p>Fig.2</p>
	<p>- REMOVE THE STARTER SUPPORT 4 SCREWS M6x25 (See Fig.3).</p> <p>(5mm ALLEN WRENCH T TYPE)</p>	 <p>Fig.3</p>
	<p>- LOOSE THE 3 SCREWS M6x35 TO REMOVE THE STARTER (See Fig.4).</p> <p>(5mm ALLEN T TYPE)</p>	 <p>Fig.4</p>
	<p>- EXTRACT THE STARTER MOTOR (See Fig.5).</p>	 <p>Fig.5</p>

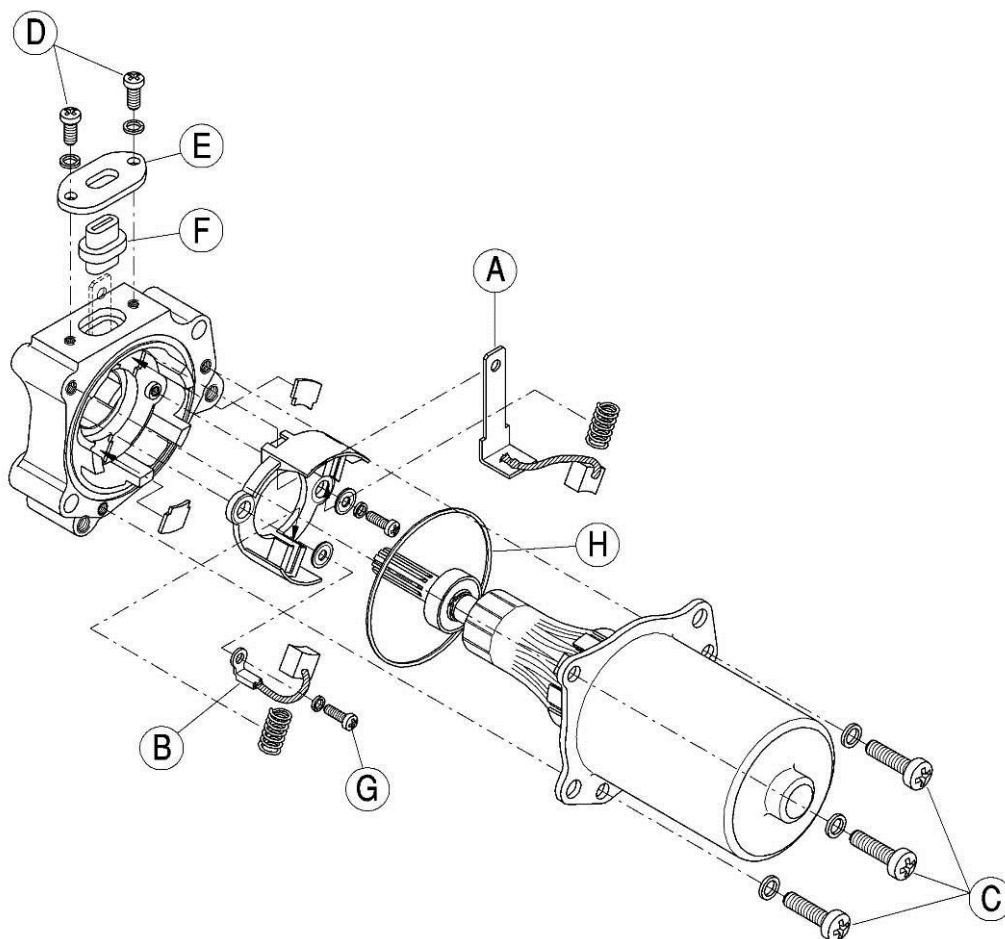

**OPENING THE STARTER MOTOR**

- UNSCREW THE M4 SCREW FIXING THE INPUT CABLE

(See Fig.6)

(SCREWDRIVER)



- UNSCREW THE 3 M5 "C" SCREWS (See Fig.7)

(SCREWDRIVER)



**Fig.6**

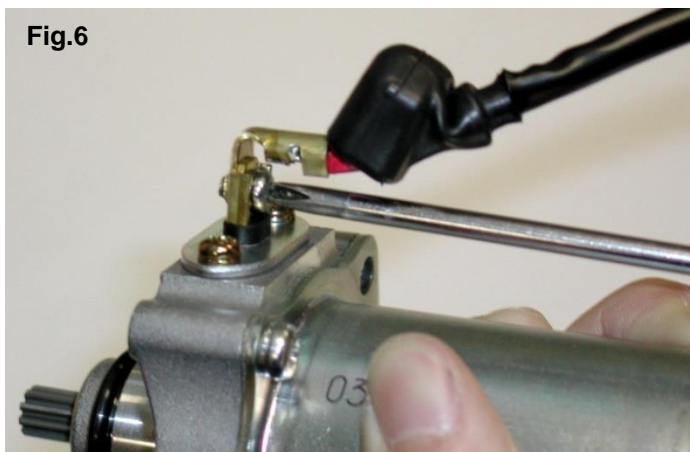

**Fig.7**

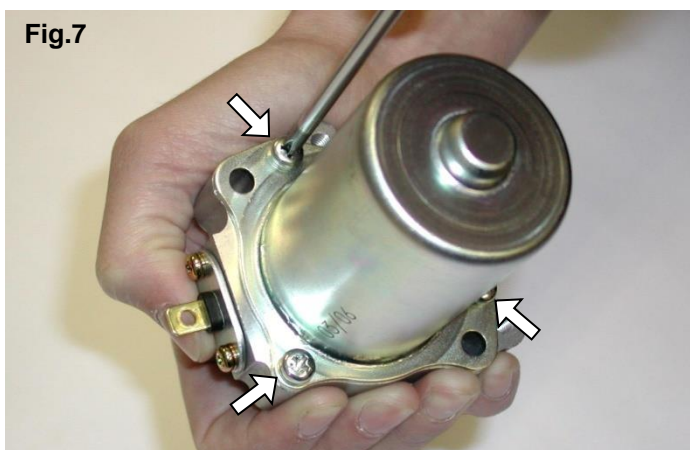

- REMOVE THE DRUM FROM THE STARTER MOTOR KEEPING THE ROTOR IN ITS SEAT (BE SURE TO HOLD THE ROTOR ON ITS TOOTHED SIDE TO PREVENT THE BRUSHES FROM FALLING OUT FROM THEIR SEAT (see Fig . 8)

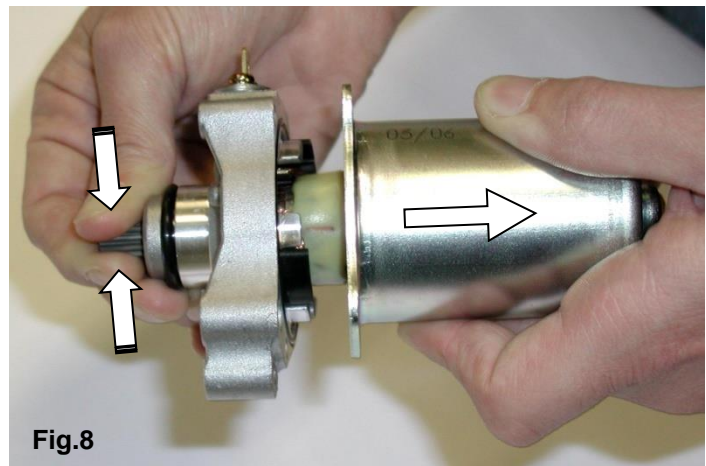

Fig.8

- EXTRACT THE ROTOR FROM THE STARTER MOTOR HEAD (see Fig. 9)

**!** **ATTENTION:**  
**WHEN EXTRACTING THE ROTOR, THE BRUSHES**  
**MAY SPRING OUT FROM THEIR SEATS.**

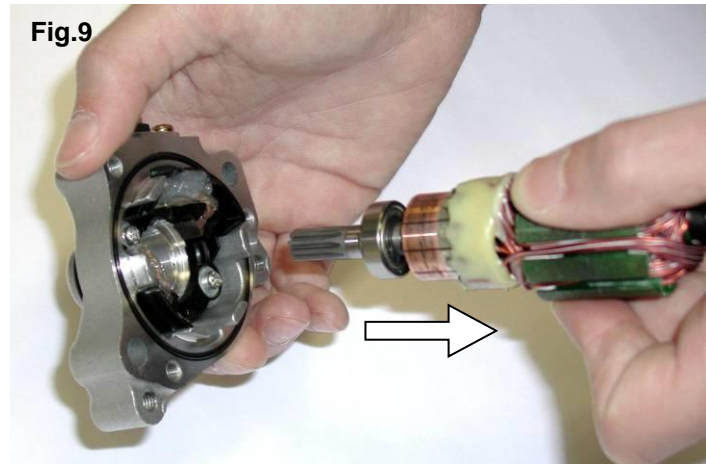

Fig.9

**REPLACING THE BRUSH "A"**

- UNSCREW THE 2 SCREWS M4 "D" RETAINING THE PLATE "E" (see Fig.10).  
(SCREWDRIVER)

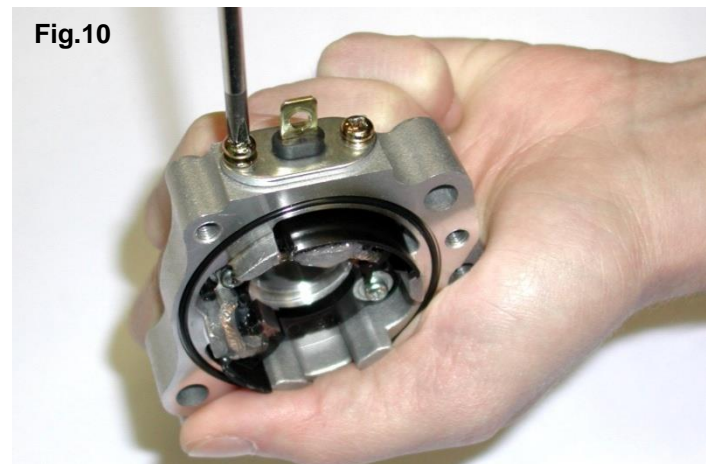

Fig.10

- REMOVE THE LITTLE RUBBER CAP "F" (see Fig.11).  
(PLIERS)



**SUGGESTION:**  
**SLIGHTLY OIL THE TIN PLATE TERMINAL END,**  
**TO MAKE THE EXTRACTION OF THE LITTLE**  
**RUBBER CAP EASIER.**

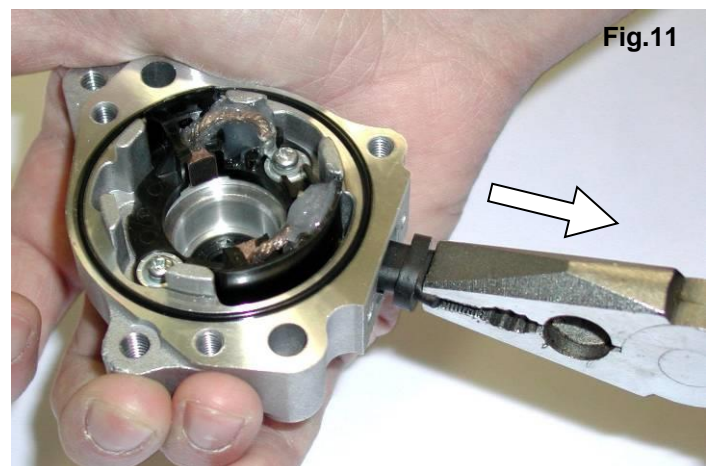

Fig.11

- REMOVE THE SILICON FROM BRUSHES WITH A SCREWDRIVER (see Fig. 11)

- REMOVE SPRINGS

- REMOVE THE BRUSH MAKING PRESSURE ON THE TIN PLATE TERMINAL EXTERNALLY (see Fig. 13)

- INSTALL NEW BRUSH TERMINAL (See Fig.14).

- PLACE THE LITTLE RUBBER CAP ON THE TERMINAL.

- REINSTALL THE PLATE AND FIX IT WITH THE 2 SCREWS M4 (See Fig.15).

(SCREWDRIVER)

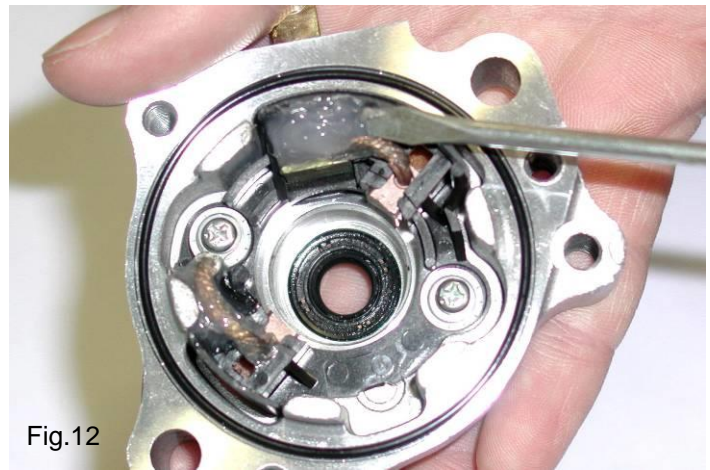

Fig.12

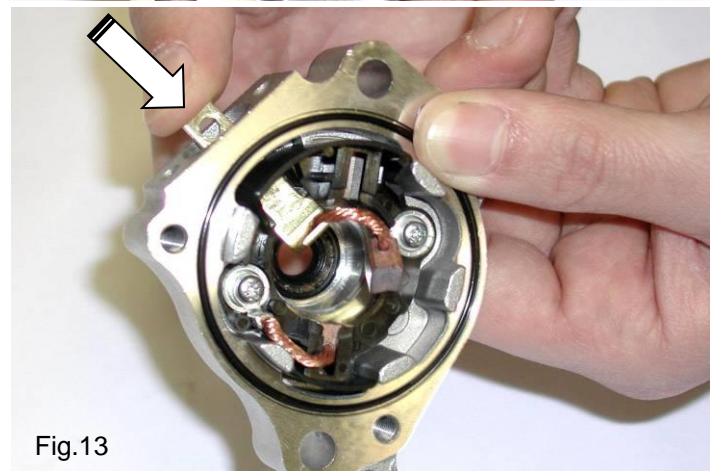

Fig.13

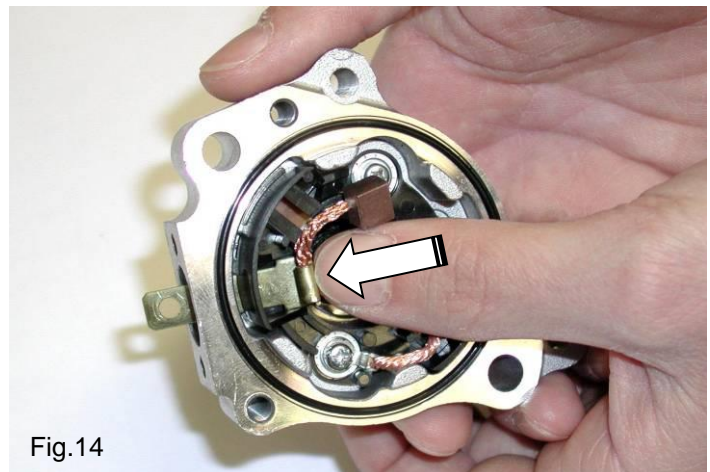

Fig.14

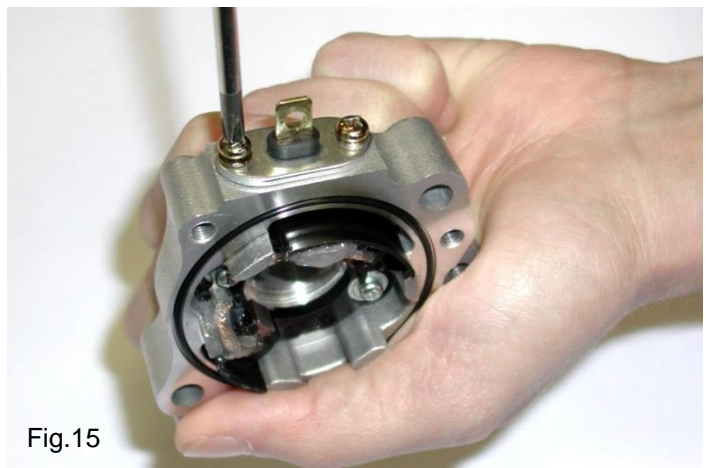

Fig.15

### REPLACEMENT OF THE BRUSH "B"

- LOOSE THE SCREW M3 "G" (See Fig.16)
- EXTRACT THE BRUSH
- FIX THE NEW BRUSH WITH SCREW M6 (SCREWDRIVER)



### CLOSING THE STARTER

- INSERT THE NEW BRUSH SPRING "A" INTO ITS SEAT.
- INSTALL THE BRUSH.
- KEEP THE BRUSH IN PLACE BY PRESSING TOWARDS THE OUTER AND CLAMP IT WITH AN IRON WIRE BENT AS A HOOK. REPEAT THE SAME PROCEDURE TO INSTALL THE BRUSH "B" (See Fig.17).
- INSTALL THE ROTOR BETWEEN THE BRUSHES AND CHECK THAT THEY ARE ALWAYS IN CONTACT WITH THE CYLINDRIC COPPER PART OF THE ROTOR, EVEN WHEN THEY ARE RELEASED. (See Fig.18).

**SUGGESTION:**  
TO IMPROVE THE BRUSHES LIFE, SECURE THE LITTLE WIRES WITH SILICONE (See Fig.19).

Fig.16

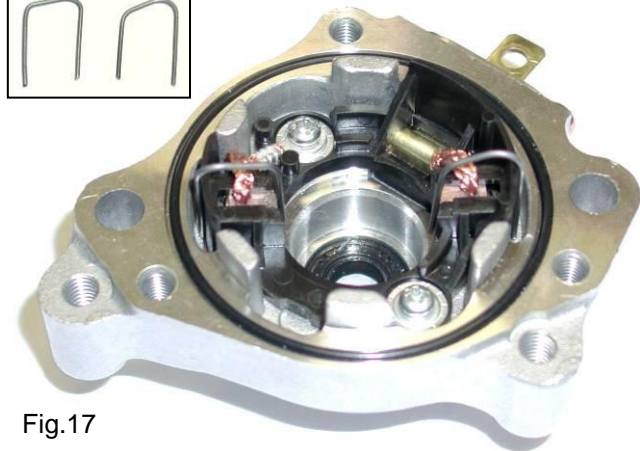
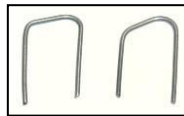
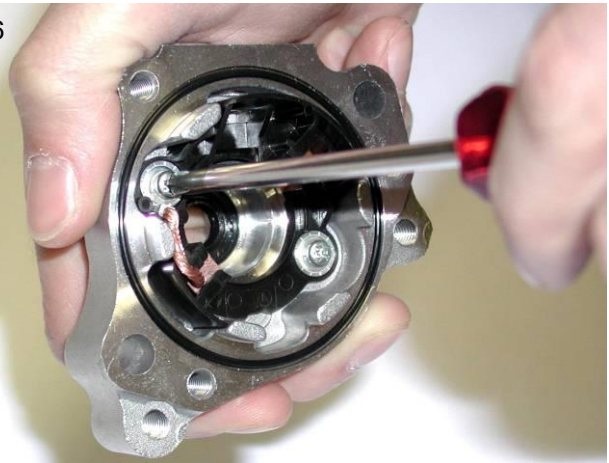

Fig.17

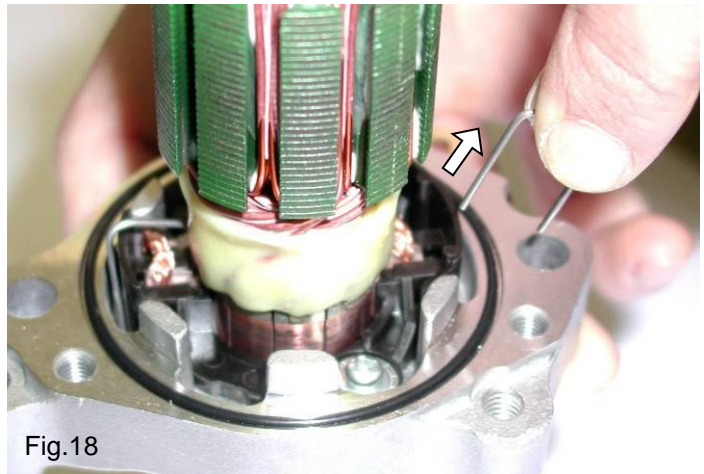

Fig.18

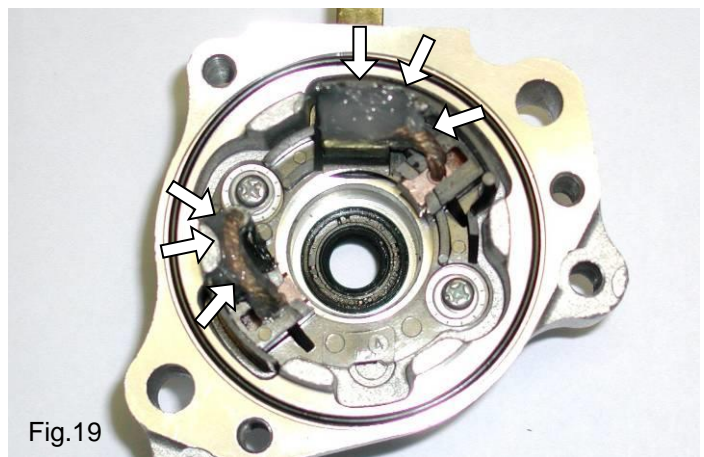

Fig.19

- CHECK THAT THE O-RING "H" IS INSTALLED ON THE STARTER HEAD.

- INSERT THE STARTER DRUM ON THE HEAD BEING CAREFUL TO PREVENT THE ROTOR FROM ROTATING AND TO PREVENT THE BRUSHES FROM FALLING OUT OF THEIR SEAT (see Fig. 20).

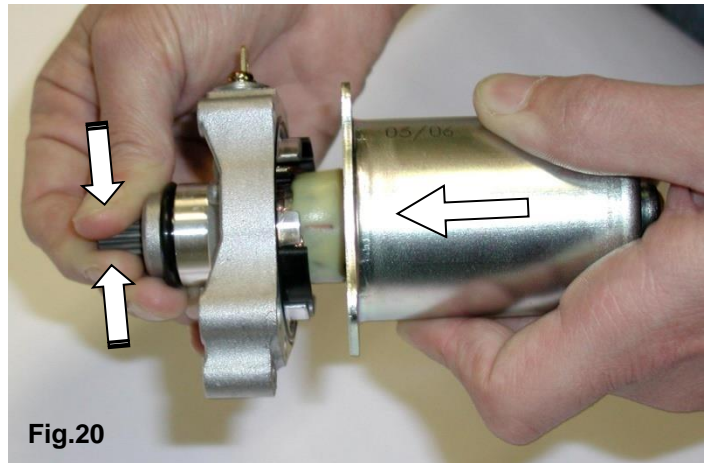

Fig.20

- TORQUE THE 3 SCREWS M5 (see Fig.21).

(SCREWDRIVER)



Fig.21

- CHECK THAT THE STARTER ROTOR ROTATES FREELY.

- CONNECT THE INPUT WIRING TO THE STARTER WITH THE SCREW M4 (see Fig.22).

(SCREWDRIVER)

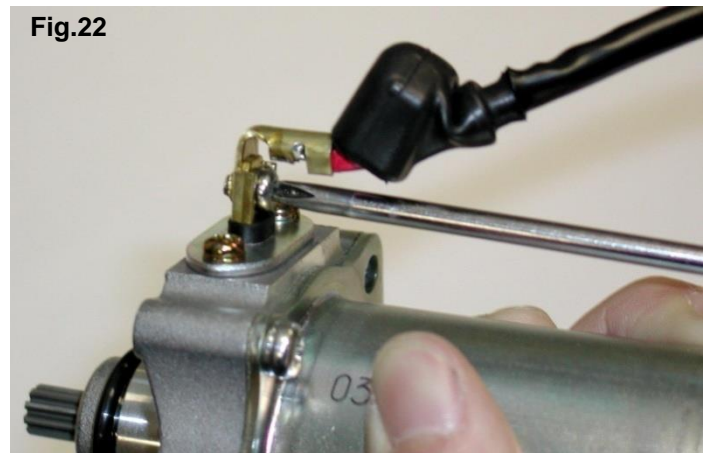

Fig.22

#### **ASSEMBLING THE STARTER**

- PLACE THE STARTER IN SEAT (see Fig.23). PUT SOME OIL ON THE O-RING TO EASE INSTALLATION N°3 SCREWS TCH M6x35 TORQUE AT  $8 \div 10$  Nm (  $70 \div 90$  in-lb )

- INSTALL THE STARTER ON THE CRANKCASE (N°4 SCREWS M6x35).

- INSTALL THE ADDITIONAL SUPPORT (N°3 SCREWS M6x25) AND TORQUE THE SCREW M6x30 ON THE SUPPORT (see Fig.23).

(5mm ALLEN WRENCH T- TYPE)



TORQUE ALL THE SCREWS AT A  $8 \div 10$  Nm (  $70 \div 90$  in-lb )



Fig.23

### 3.14- SCHEDULE MAINTENANCE

Following some simple maintenance standards will allow the engine to perform more reliably and have a longer life.

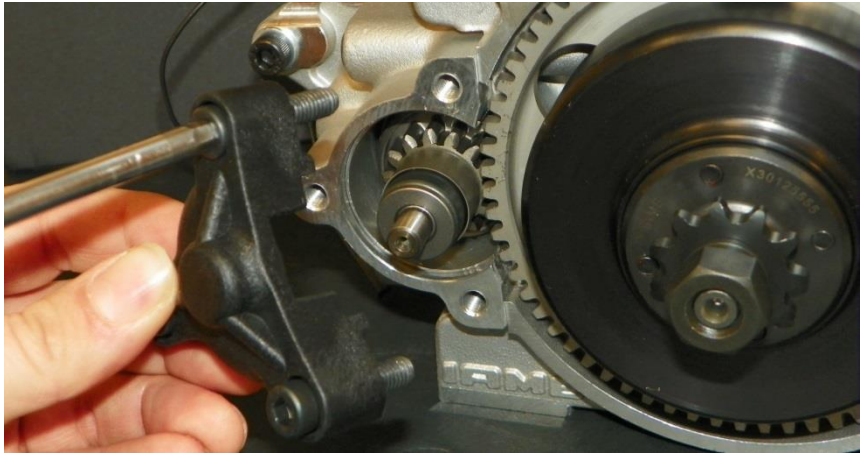
SCHEDULE	COMPONENTS	ACTIONS AND COMMENTS	
<b>Before each use</b>	Flexible spring	Check status	
	Muffler	Check status and fixing (springs)	
	Engine sprocket	Check wear Check alignment with axle sprocket	
	Engine chain	Check wear, tensioning and chain lubrication	
	Battery	Check status and charge	
	Cables and connectors	Check status and restore the connections	
	Grounding engine	Check status and restore the connections	
<b>After each use</b>	Battery support, bracket and clamps	Check torques	
	Battery	Disconnect	
	Chain	Lubrification	
<b>Every 5 ÷ 10 hours</b>	Engine	External cleaning	
	Bendix starter	Remove cover (see fig.) and clean internally.	
			
	Exhaust muffler	Remove muffler end, clean	
	Inlet silencer	Open , clean	
<b>Every 7 hours</b>	Engine head	Open , clean	
	Clutch	Open, check status of parts and if necessary replace part.	
	<b>Every 60 hours</b>	Piston and con-rod assembly	Check and replace worn parts
	<b>Every 30 to 60 hours</b>	Crankshaft	Replace worn parts
	Main bearings	Replace worn parts	



### 3.15- TROUBLESHOOTING

Here below there are some of the most common problems, the possible causes and the recommended solutions to solve them.

<b>PROBLEMS</b>	<b>PROBABLE CAUSES</b>	<b>SOLUTIONS</b>
<b>Starter will not crank when pushing the start button</b>	Bad connections on starter cables	Check connections and tighten
	Bad grounding	Check connections and tighten
	Damaged cables	Replace them
	Battery connection loose	Check and tighten connections
	Battery discharged	Recharge or replace battery
	Damaged starter	Check
<b>Starter cranks but engine won't start</b>	Bad cable connections	Check that connectors are properly connected.
	Bad H.T. Coil connections or coil failure	Check/replace
	Bad H.T. coil grounding	Check grounding
	Wet spark plug	Replace
	Malfunction on induction system	Check status and connection on fuel pipe Replace membranes and gaskets on carburettor
<b>Pushing the start button, the engine starts but turns off after a short time.</b>	Bad harness connections	Check connectors
	Bad carburettor setting (screw l)	Check carburettor setting (see sect. 3.2)
<b>The starter turns also after releasing the start button.</b>	Battery not sufficiently charged (sticking of the starter relay)	Remove the positive pole of the battery to stop the engine and recharge the battery.
<b>The engine stops at minimum</b>	Bad setting of idle screw on carburettor ( screw L)	Check carburettor setting (see sect. 3.2)
<b>The engine shows a performance drop</b>	Bad compression	Check piston status
	Bad carburettor setting	Check carburettor setting (see sect. 3.2)
	Insufficient power system	Check fuel flow and inlet filter.
	Blocked inlet silencer	Check and clean
<b>Burning smell, presence of smoke</b>	Clutch overheating	Check the clutch status (see sect. 3.8)
<b>Clutch engages at too high RPM</b>	Excessive wear of the friction material	Check the clutch status (see sect. 3.8)
<b>Too much noise coming from the exhaust system</b>	Damaged flexible	Check and replace if necessary
	Damaged or lost springs	
	Damaged or lost insulating tape	
	Damaged exhaust pipe	

### 3.16- MAIN PRESCRIPTIONS

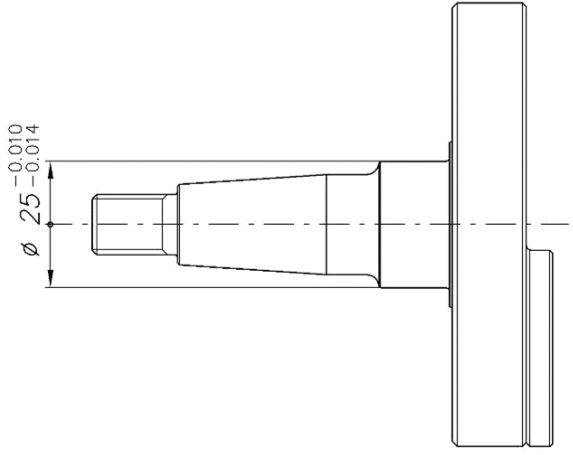
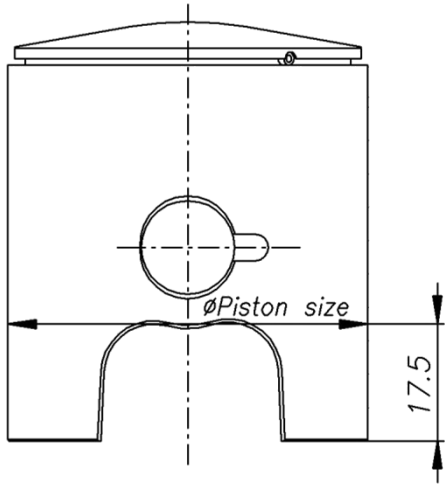
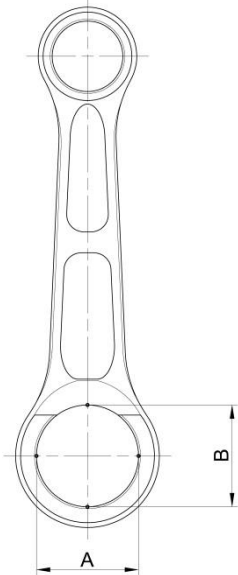
ENGINE CRANKSHAFT	MATCHING THE PISTON
 <p><b>Bearing seat diameter on new engine</b></p> <p>Refer to the attached table to define the state of wear of the drive shafts. Replace when size is lower than 0.03mm vs. original.</p> <p><b>!</b> The <b>replacement operation</b> must be carried out after about a use of <b>60 hours</b>.</p>	 <p><b>!</b> <b>ATTENTION:</b> <u>Clearance between piston and liner must be: 0.090 / 0.095mm.</u></p> <p><u>If clearance is higher than 0.14mm, must be replaced the piston.</u></p>
MAX ALLOWED OVALIZATION ON CONROD	<p><b>!</b> An inspection must be carried out after about a use of 45 liters or 5 hours of use, and the pistons are measured at 17.5mm from bottom.</p> <p>The <b>replacement operation</b> must be carried out about a use of <b>10 hours or 80 litres</b>.</p> <p>Size of the liner to be matched with piston is marked on top of piston.</p> <p>Allowed ring gap <b>0.15÷0.40 mm</b>.</p>
 <p><b>Max. allowed ovalization between A and B on new conrod: 0.002mm</b></p> <p><b>Max. allowed ovalization between A and B on used conrod: 0.01mm</b></p> <p><b>!</b> An inspection must be carried out after about 30 hours use. When ovalization reaches 0,01mm (the difference between the measured diameter in the positions shown below "A" and "B") the conrod must be replaced.</p> <p>The <b>replacement operation</b> must be carried out after about a use of <b>60 hours</b>.</p>	ESTIMATED AVERAGE LIFE OTHER COMPONENTS
	<p>Big End Conrod Roller + Bearing + Crankpin + Silver washer = 30 hours</p>
	<p>Little End Conrod + Roller Bearing + Piston Pin = 10 to 20 hours</p>

### 3.17- WEAR STATUS EVALUATION CHART - BEARINGS AND HALF CRANKSHAFT

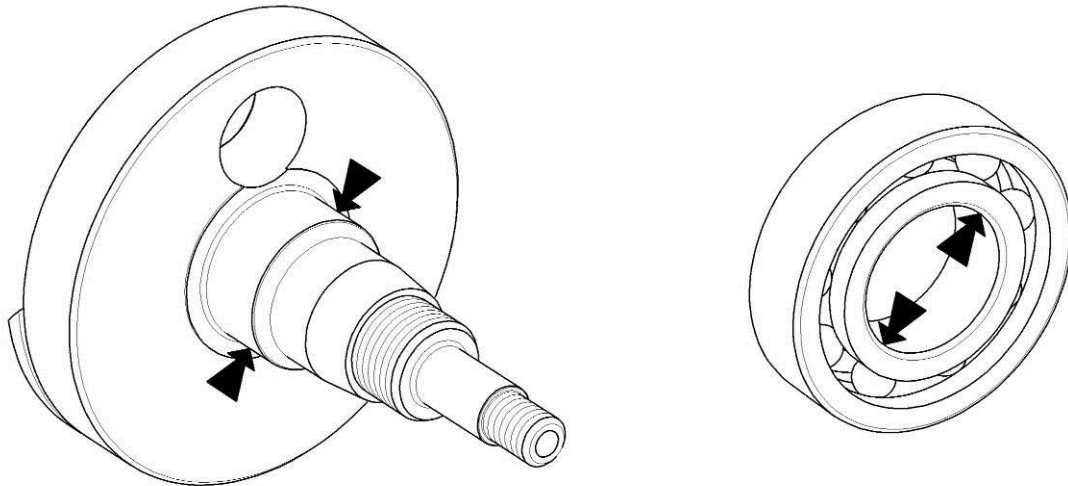

**NOTE:**

**ALWAYS CHECK DIMENSIONS IN DIFFERENT POINTS ON THE CIRCUMFERENCE, LOOKING FOR EVENTUAL OVALIZATIONS.**

The following chart shows the ovalization limits over which replacement is required

MEASURED PART (MEASURING INSTRUMENT)	LIMITS	Replace after Hours for Using
CRANKSHAFT – BEARING SEAT (MICROMETER 25 ÷ 50 1/100)	MIN. Ø24.96	60h
CRANKSHAFT BEARINGS (1/100 BORE GAUGE WITH CHECK RING Ø25)	* MAX. Ø25.03	30h



**ATTENTION:**

**THE MEASURED VALUE ON THE BEARING MUST ALWAYS BE COMPARED WITH THE SEAT VALUE (ON SHAFT AND/OR BALANCE SHAFT), TO CHECK THAT PLAY BETWEEN SHAFT AND BEARING DOES NOT EXCEED THE LIMIT VALUE OF 0.05mm.**

<b>MATCHING PLAYS - CONROD LOWER END</b>				
CONROD END	Ø CRANK PIN	ØROLLERS ON CAGE	PLAY	
			MIN.	MAX.
26 <sup>+0.024</sup> <sub>+0.020</sub>	20 <sup>-0.004</sup> <sub>-0.008</sub>	3 <sup>0</sup> <sub>-0.002</sub>	0.027	0.033

<b>MATCHING PLAYS - CONROD UPPER END</b>					
CONROD END	Ø PISTON PIN		ØROLLERS ON CAGE	PLAY	
	RED	WHITE YELLOW		MIN.	MAX.
18 <sup>+0.016</sup> <sub>+0.012</sub>	14 <sup>+0.002</sup> <sub>0</sub>			0.010	0.020
		14 <sup>0</sup> <sub>-0.002</sub>	2 <sup>0</sup> <sub>-0.002</sub>	0.012	0.022
		14 <sup>-0.002</sup> <sub>-0.004</sub>		0.014	0.024

### 3.19- ENGINE AND ACCESSORIES PRESERVATION

When the engine is not operating for a long period, it must be preserved in the most suitable way:

- Disconnect the battery and recharge it regularly (see sect. 3.10)
- Disassemble the carburettor and clean it
- Seal the inlet and the exhaust with adhesive paper

External parts must be cleaned and steel parts, subject to oxidation, protected with light film oil. Keep the engine in a dry place.

### 3.20- TORQUE VALUES

NOMINAL SIZE	Q.TY	FASTENER NAME	WRENCH	VALUES (Nm)
M14x1,25	1	Spark Plug	Hex.20,8	20 ÷ 26
M8x1,25	4	Head and Cylinder Nuts	Hex.13	18 ÷ 22
M8x1,25	2	Exhaust manifold Stud Nuts	Hex.13	18 ÷ 22
M6x1	4	Reed Group Screws	Allen 5	8 ÷ 10
M5x0,8	3	Coil Attack Screws	Allen 4	5 ÷ 6
M5x0,8	2	Ignition Stator Fixing Screws	Allen 4	5 ÷ 6
M10x1	1	Ignition Rotor Fixing Nuts	Hex.17	20 ÷ 26
M6x1	3	"Bendix" Support Cover Screws	Allen 5	6 ÷ 8
M6x1	4	"Bendix" Support Screws	Allen 5	6 ÷ 8
M6x1	4	Starter Support Fixing Screws	Allen 5	8 ÷ 10
M6x1	3	Clutch Cover Fixing Screws	Allen 5	8 ÷ 10
M10x1	1	Clutch Drum Fixing Nut	Hex.17	30 ÷ 40
M20x1	1	Starter Ring Fixing Nut	Hex.27	100 ÷ 110
M5x0,8	4	Engine Sprocket Fixing Screws	Allen 3	6 ÷ 8
M6x1	3	Starter Ring Fixing Screws	Allen 5	10 ÷ 12
M6x1	8	Crankcase Fixing Screws	Allen 5	8 ÷ 10

### 3.21 – WIRING DIAGRAM

